

FLUIDIC PRODUCTS AND INFORMATION

BIOTECH is a Premium Distributor
for IDEX Health & Science

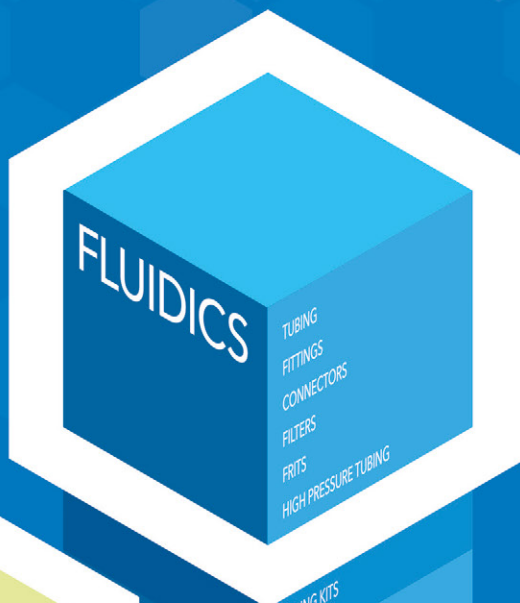

TUBING KITS
TOOLS
CONED FITTINGS
FLAT BOTTOM FITTINGS
UHPLC FITTINGS
VHP FITTINGS
PLUGS & CAPS
ACCESSORIES
FLANGED FITTINGS
SPECIALTY FITTINGS



Intelligent Solutions for Life™
Fluidics | Optics | Consumables | Assemblies

GLOBAL PREMIUM DISTRIBUTOR FOR IDEX

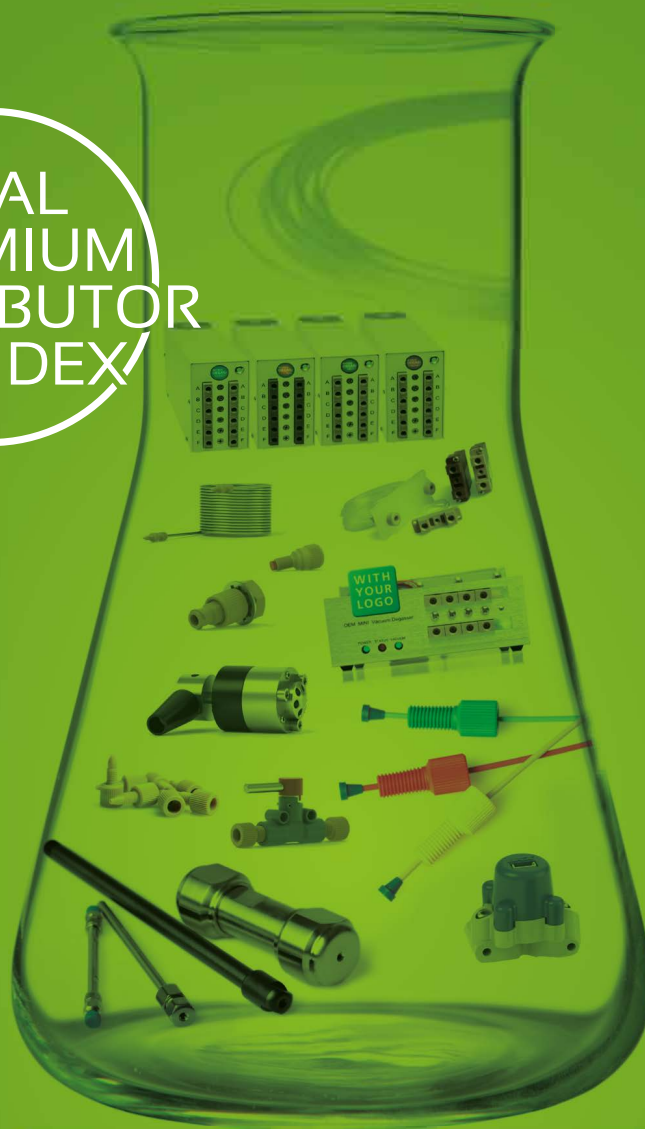

GLOBAL PREMIUM DISTRIBUTOR

Biotech AB in Sweden/Europe (Headquarter),
Biotech USA LLC and Bionik Inc Japan are Global
Premium Distributors of IDEX Health & Science.

FAST DELIVERY

With several weekly shipments from IDEX manufacturing sites in US, together with our extensive Swedish warehouse, we support the European & Global market with short delivery times as well as fast answers on technical questions and a high level of flexibility.

LOCAL DISTRIBUTORS

In almost every European country we work in close co-operation with local distributors that supports you with excellent daily service, long experience and highest level of technical assistance.

FULL IDEX ASSORTMENT

With the full IDEX assortment of components for fluidic systems along with our long experience and know-how in the field we can assure you to always do our very best in supplying you with excellent solutions and products. Customized OEM solutions, especially in the field of degassing, is something we offer to instrument manufacturers globally.



BIOTECH + IDEX = EVERYTHING FOR THE LAB

KNOW-HOW AND A WIDE ASSORTMENT

As Global Premium Distributor for IDEX we have special know-how about their assortment and can provide you with the right mix of products for a successful lab.

We have cutting edge knowledge to tailor the system for laboratories' specific needs for fluidic handling. You will find a wide range of products to suit every possible flow rate and type of fluid. In this field, we offer a number of well-known brands, such as Systec, Upchurch, Rheodyne and Isolation Technologies - all to give you the best solutions.

GREAT FLUIDIC SOLUTIONS



www.biotechfluidics.com

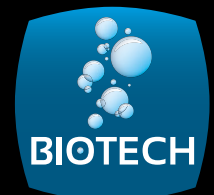

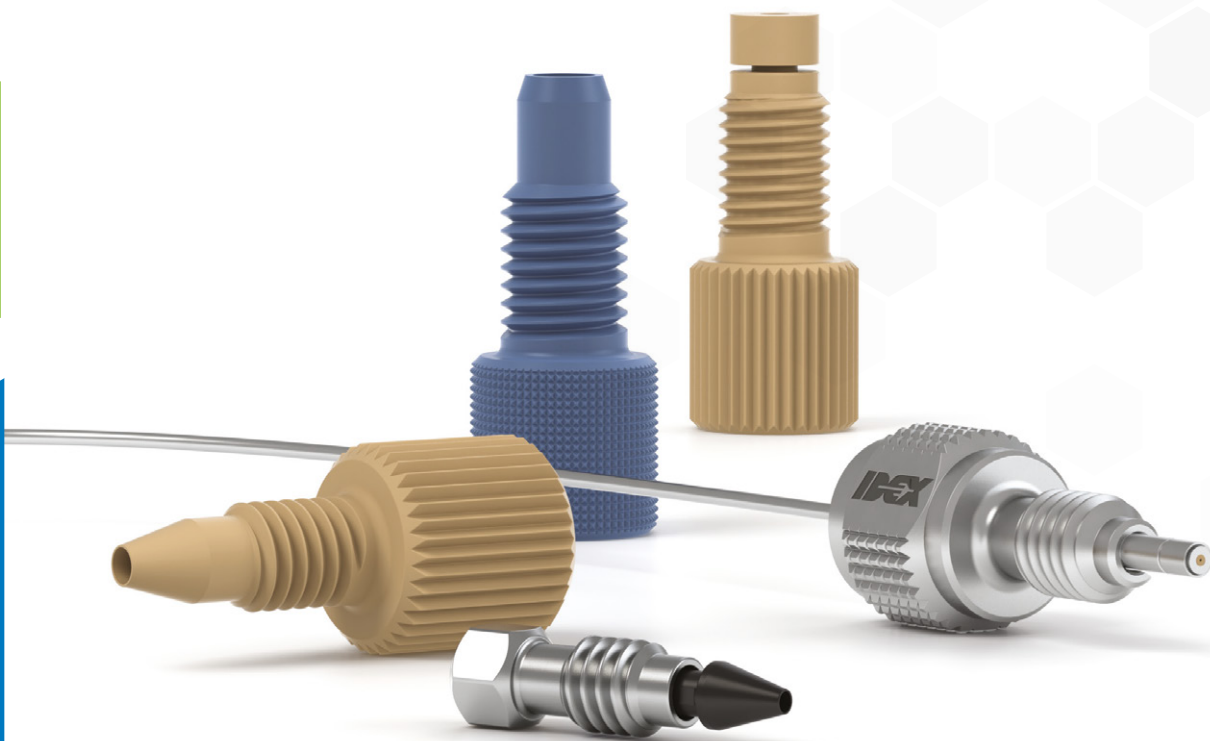

FITTINGS

We offer a wide and diverse selection of fittings to meet your system requirements. A “fitting” refers to a complete product ready to assemble and connect tubing into a part. This could be a one-piece connector or a nut and ferrule packaged together. A “Nut” indicates the male or female threaded product sold separately, and a “Ferrule” is sold separately when indicated in the description. For your convenience we ship most Fittings and Ferrules in 10-packs. We are dedicated to providing the most reliable, proven products on the market. We have implemented more stringent testing protocols and a generous safety margin to our ratings to ensure your safety.

32 CONED FITTINGS

39 FLAT-BOTTOM FITTINGS

48 MARVELX™

50 FITTINGS TOOLS

56 LARGE BORE FITTINGS

57 VHP FITTINGS

61 FITTINGS KITS



NOTE

All testing is performed with water at room temperature unless otherwise specified. Please contact IDEX Health & Science directly for further details. Results may vary depending on the material of the receiving port and tubing, actual tubing diameters (with stated tolerances), temperature and solvents used. If a pressure range is listed for a product's specification, the pressure rating depends on the tubing material used. The lower end of the range will represent testing performed on softer tubing such as FEP, and the higher end of the range will represent testing performed on harder tubing such as Stainless Steel. For more detail, please see the product specification sheets on our website, www.idex-hs.com, or contact us directly.



APPLICATION NOTE

What Threads Do I Have?

Hold your fitting over the thread silhouettes below to identify the threads.

U.S. CUSTOMARY THREADS

6-40



6-32



10-32



1/4-28



5/16-24



1/2-20



METRIC THREADS

M4 x 0.7



M6 x 1





One-Piece Fingertight Fittings

- › The original One-Piece Fingertight Fitting
- › All polymer construction
- › Versions available for 1/16", 1/32" or 1/8" OD tubing
- › Convenient and easy to use
- › Reusable

NOTE

- › Some of the fittings on this page are available in additional colors. Please contact your distributor or us for more information.
- › Fingertight is generally equal to 3–4 in-lbs (0.34–0.45 N·m).

Our One-Piece Fingertight Fittings provide convenience and ease of use because the ferrule will not stick in a receiving port and the fitting is more easily found if dropped. The fittings for 1/16" OD tubing and 10-32 coned ports are available in a variety of colors, materials and lengths to suit virtually every application.

Beyond the standard 10-32 fittings, also featured in this product family are specialty fittings for specific applications. Our M-645 Fitting is a direct replacement for the 6-40 threaded VICI® (Valco) fitting. The P-100 can be used in 1/4-28 coned ports for 1/8" OD tubing including some of the inlet filters starting on page 102.

RheFlex® One-Piece Fittings are included in many of the manual valves, starting on page 121. The One-Piece RheFlex M4 Fittings, for use with our MX Nano-Scale Modules, are listed on page 61.

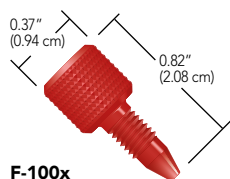

F-100x
10-32 PCTFE Fitting

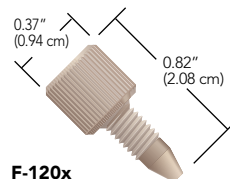

F-120x
10-32 PEEK Fitting

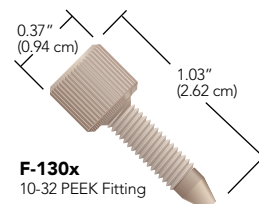

F-130x
10-32 PEEK Fitting

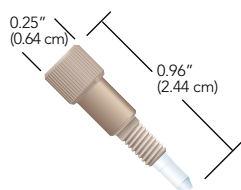

M-645x
6-40 PEEK/PCTFE Fitting
for 1/32" OD tubing

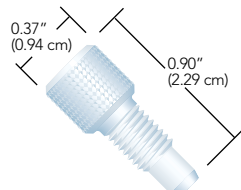

P-100
1/4-28 PCTFE Fitting
for 1/8" OD tubing

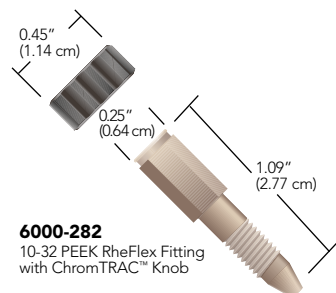

6000-282
10-32 PEEK RheFlex Fitting
with ChromTRAC™ Knob

Part No.	Description	Port	Pressure Rating	Head Style	Material	Qty.
ONE-PIECE FINGERTIGHT FITTINGS						
6000-282	Fingertight Fitting for 1/16" OD Tubing	10-32 Coned	5,000 psi (345 bar)	ChromTRAC knob	PEEK, Natural	10-pk
F-100x	Fingertight Fitting for 1/16" OD Tubing	10-32 Coned	4,000 psi (276 bar)	Diamond Knurl	PCTFE, Red	10-pk
F-120x	Fingertight Fitting for 1/16" OD Tubing	10-32 Coned	5,000 psi (345 bar)	Standard Knurl	PEEK, Natural	10-pk
F-130x	Fingertight Fitting for 1/16" OD Tubing, Long	10-32 Coned	5,000 psi (345 bar)	Standard Knurl	PEEK, Natural	10-pk
M-645x	Fingertight Fitting for 1/32" OD Tubing	6-40 Coned	1,750–3,250 psi (121–224 bar)	Headless Knurl	PEEK, Natural/PCTFE, Natural	10-pk
P-100	Fingertight Fitting for 1/8" OD Tubing	1/4-28 Coned	1,000 psi (69 bar)	Diamond Knurl	PCTFE, Natural	ea.

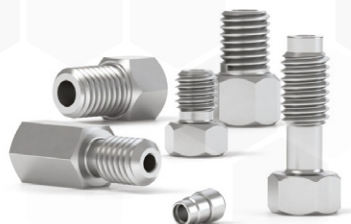

Stainless Steel Fittings

NOTE

- Do not use metal fittings in plastic ports, as this can damage the port.
- The recommended torque to tighten these fittings is 20 in-lbs (2.25 N·m).

These 316 Stainless Steel Fittings are rated to 20,000 psi (1,380 bar) when wrench tightened. Choose IDEX Health & Science standard fittings, or select from the Common Valve Fittings or other manufacturer-compatible offerings.

Standard Stainless Steel Fittings

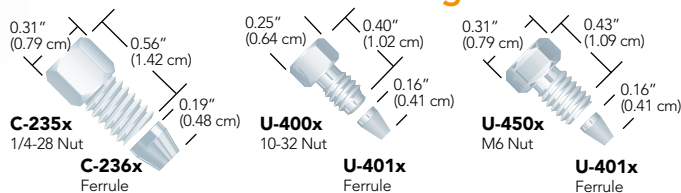

Common Valve Fittings

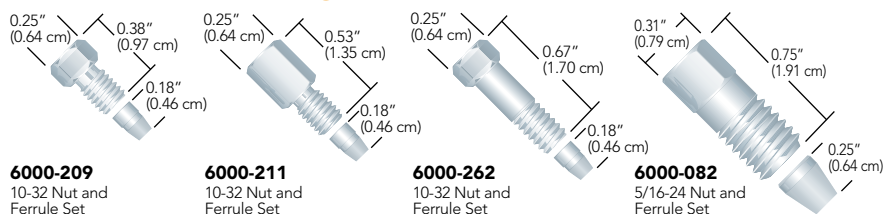

Beckman® Compatible Fittings

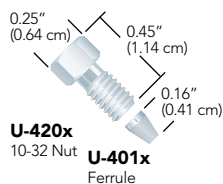

VICI® (Valco) Compatible Fittings

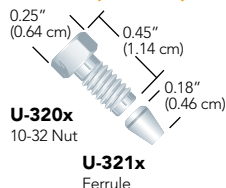

Part No.	Description	Port	Pressure Rating	Head Style	Material	Qty.
STANDARD STAINLESS STEEL FITTINGS						
C-235x	Nut for 1/8" OD Tubing	1/4-28 Coned	20,000 psi (1,380 bar)	5/16" Hex	SST	10-pk
C-236x	Ferrule for 1/8" OD Tubing	1/4-28 Coned	20,000 psi (1,380 bar)	—	SST	10-pk
U-400x	Nut for 1/16" OD Tubing	10-32 Coned	20,000 psi (1,380 bar)	1/4" Hex	SST	10-pk
U-401x	Ferrule for 1/16" OD Tubing	10-32 or M6 Coned	20,000 psi (1,380 bar)	—	SST	10-pk
U-450x	Nut for 1/16" OD Tubing	M6 Coned	20,000 psi (1,380 bar)	5/16" Hex	SST	10-pk
COMMON VALVE FITTINGS						
6000-082	Fitting for 1/8" OD Tubing	5/16-24 Coned	20,000 psi (1,380 bar)	5/16" Hex	SST	ea.
6000-083	Ferrule for 1/8" OD Tubing	5/16-24 Coned	20,000 psi (1,380 bar)	—	SST	5-pk
6000-209	Fitting for 1/16" OD Tubing	10-32 Coned	20,000 psi (1,380 bar)	1/4" Hex	SST	10-pk
6000-210	Ferrule for 1/16" OD Tubing	10-32 Coned	20,000 psi (1,380 bar)	—	SST	10-pk
6000-211	Fitting for 1/16" OD Tubing, Long	10-32 Coned	20,000 psi (1,380 bar)	1/4" Hex	SST	10-pk
6000-262	Fitting for 1/16" OD Tubing, Extra Long	10-32 Coned	20,000 psi (1,380 bar)	1/4" Hex	SST	10-pk
MANUFACTURER COMPATIBLE FITTINGS						
U-320x	Nuts for 1/16" OD Tubing, Valco/VICI Compatible	10-32 Coned	20,000 psi (1,380 bar)	1/4" Hex	SST	10-pk
U-321x	Ferrule for 1/16" OD Tubing, Valco/VICI Compatible	10-32 Coned	20,000 psi (1,380 bar)	—	SST	10-pk
U-410x	Nuts for 1/16" OD Tubing, Waters Compatible	10-32 Coned	20,000 psi (1,380 bar)	5/16" Hex	SST	10-pk



MicroTight® Fittings

- › Comprehensive Fitting System for Connecting Capillary Tubing
- › Made from PEEK Polymer

MicroTight® One-Piece Fittings are designed for use with the NanoPort™ and MicroTight Unions, Adapters and Inline MicroFilters. Specifically made for 360 µm OD tubing, 1/32" OD tubing, or our MicroTight Tubing Sleeves (see page 52), these fittings make superior fingertight connections with capillary tubing. MicroTight Fittings withstand temperatures up to 125 °C.

The MicroTight family also includes a female nut matched with one of five dedicated ferrules for connecting specific tubing ODs.

Use the P-277 Extender Tool to tighten standard micro knurl 6-32 fittings in hard-to-reach places. Tighten micro headless 6-32 fittings with our N-290 Tool. See page 50 for more information.



NOTE

MicroTight fittings and MicroFerrules

While the MicroTight Female Nuts may be used with any of the separate MicroFerrules, the MicroFerrules themselves are port-specific and are thus not interchangeable. Additionally, the one-piece MicroTight fittings are also port-specific and should not be exchanged.



F-1245x
Standard Head Fitting
for use with
360 µm OD tubing

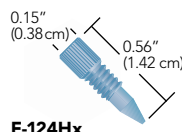

F-124Hx
Headless Fitting
for use with
360 µm OD tubing

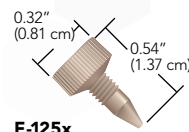

F-125x
Standard Head Fitting
for use with
MicroTight Sleeves

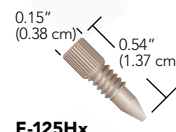

F-125Hx
Headless Fitting
for use with
MicroTight Sleeves

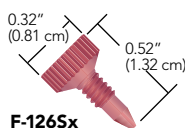

F-1265x
Standard Head Fitting
for use with 1/32" OD tubing

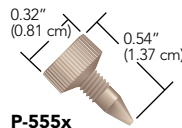

P-555x
Standard Head Plug

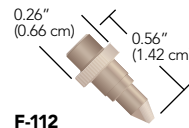

F-112
MicroFerrule for
1/32" OD tubing



F-132
MicroFerrule for
1/16" OD tubing

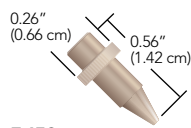

F-152
MicroFerrule for
360 µm OD tubing

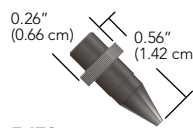

F-172
MicroFerrule for
0.025" OD tubing

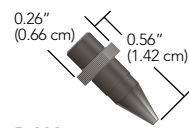

P-116
MicroFerrule Plug

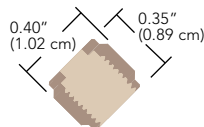

P-416
Female Nut
5/16-24 internal threads



P-416BLK
Female Nut
5/16-24 internal threads



P-416G
Female Nut
5/16-24 internal threads



RELATED PRODUCTS

- › Connectors for Capillary Tubing can be found on page 75.
- › Very High Pressure fittings for capillary tubing can be found on page 58.
- › Capillary tubing is featured on page 16.

Part No.	Description	Port	Pressure Rating	Head Style	Material	Qty.
MICROTIGHT FITTINGS						
F-124Hx	MicroTight Fitting for 360 µm OD Tubing	6-32 Coned	5,000 psi (345 bar)	Micro Headless Knurl	PEEK Blue	10-pk
F-1245x	MicroTight Fitting for 360 µm OD Tubing	6-32 Coned	5,000 psi (345 bar)	Standard Micro Knurl	PEEK Blue	10-pk
F-125Hx	MicroTight Fitting for MicroTight Tubing Sleeves	6-32 Coned	4,000 psi (276 bar)	Micro Headless Knurl	PEEK Natural	10-pk
F-125x	MicroTight Fitting for MicroTight Tubing Sleeves	6-32 Coned	4,000 psi (276 bar)	Standard Micro Knurl	PEEK Natural	10-pk
F-1265x	MicroTight Fitting for 1/32" OD Tubing	6-32 Coned	5,000 psi (345 bar)	Standard Micro Knurl	PEEK Red	10-pk
P-555x	MicroTight Plug	6-32 Coned	5,000 psi (345 bar)	Standard Micro Knurl	PEEK Natural	10-pk
MICROFERRULES AND FEMALE NUTS						
F-112	MicroFerrule for 1/32" OD Tubing	5/16-24 Coned	5,000 psi (345 bar)	—	PEEK Natural	ea.
F-132	MicroFerrule for 1/16" OD Tubing	5/16-24 Coned	5,000 psi (345 bar)	—	PEEK Natural	ea.
F-152	MicroFerrule for 360 µm OD Tubing	5/16-24 Coned	5,000 psi (345 bar)	—	PEEK Natural	ea.
F-152BLK	MicroFerrule for 360 µm OD Tubing	5/16-24 Coned	5,000 psi (345 bar)	—	PEEK Black	ea.
F-172	MicroFerrule for MicroTight Tubing Sleeves	5/16-24 Coned	4,000 psi (276 bar)	—	PEEK Black	ea.
P-116	MicroFerrule Plug	5/16-24 Coned	5,000 psi (345 bar)	—	PEEK Black	ea.
P-416	MicroTight Female Nut	5/16-24 Coned	4,000–5,000 psi (276–345 bar)	Female Knurl	PEEK Natural	ea.
P-416BLK	MicroTight Female Nut	5/16-24 Coned	4,000–5,000 psi (276–345 bar)	Female Knurl	PEEK Black	ea.
P-416G	MicroTight Female Nut	5/16-24 Coned	4,000–5,000 psi (276–345 bar)	Female Knurl	PEEK Green	ea.

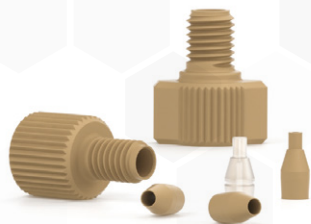

Two-Piece Fingertight Fittings

- › Designed to connect tubing to 10-32 coned ports
- › Ferrules available for directly connecting 1/16", 1/32", 360 µm, or 190 µm OD tubing
- › Economical, replace only the ferrule



APPLICATION NOTE

Some Fingertight Nuts feature wings in addition to a knurled head, which provide more leverage when tightening the fitting into a receiving port. Choose our single or double-winged design.

Please Note: customers can use the standard knurl head fittings with our tightening tools found on page 50.

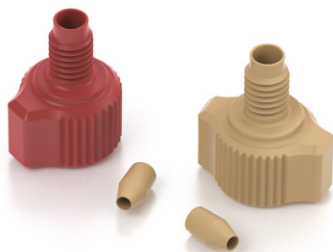

Two-Piece Fingertight Fittings feature a separate ferrule. Use a standard knurled head fitting for traditional fingertight applications, or use a fitting with wings built into the head for extra tightening leverage. A stainless steel hex headed fitting can be used for applications where a wrench may be needed for added tightening torque.

The M-215 Conductive Perfluoroelastomer Ferrule is designed for mass spectrometer electrospray applications. Unlike most graphite ferrules, the elastomeric properties of this ferrule let you use it through many tightening/retightening cycles. It also eliminates any possibility of graphite contamination in your system. Like graphite ferrules, you can apply voltage through a metallic port block or metallic nut, allowing voltage to translate to the flow path through the ferrule.

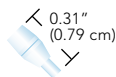

F-148
PCTFE Ferrule
for 190 µm OD tubing

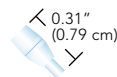

F-151
PCTFE Ferrule
for 360 µm OD tubing

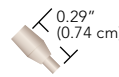

F-113
PEEK Ferrule
for 1/32" OD tubing

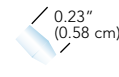

F-142N
ETFE Ferrule
for 1/16" OD tubing



M-215
Conductive
Perfluoroelastomer
Ferrule for 360 µm
OD tubing

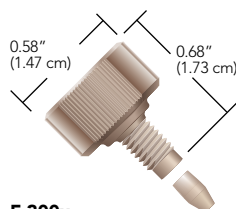

F-300x
10-32 PEEK Double-Winged Nut
with F-142x PEEK Ferrule

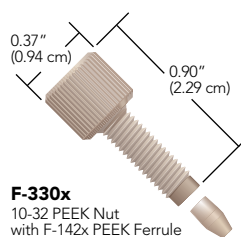

F-330x
10-32 PEEK Nut
with F-142x PEEK Ferrule

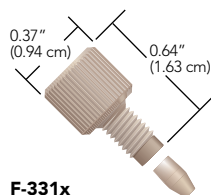

F-331x
10-32 PEEK Nut
with F-142x PEEK Ferrule

Part No.	Description	Port	Pressure Rating	Head Style	Material	Qty.
TWO-PIECE FINGERTIGHT FITTINGS (INCLUDES F-142 FERRULES)						
F-300x	Fingertight Fitting for 1/16" OD Tubing	10-32 Coned	6,000 psi (414 bar)	Double Wing	PEEK Natural	10-pk
F-330x	Fingertight Fitting for 1/16" OD Tubing, Long	10-32 Coned	6,000 psi (414 bar)	Standard Knurl	PEEK Natural	10-pk
F-331x	Fingertight Fitting for 1/16" OD Tubing	10-32 Coned	6,000 psi (414 bar)	Standard Knurl	PEEK Natural	10-pk
REPLACEMENT FERRULES						
F-113	Ferrule for 1/32" OD Tubing	10-32 Coned	6,000 psi (414 bar)	—	PEEK Natural	ea.
F-142	Ferrule for 1/16" OD Tubing	10-32 Coned	6,000 psi (414 bar)	—	PEEK Natural	ea.
F-142N	Ferrule for 1/16" OD Tubing	10-32 Coned	4,000 psi (276 bar)	—	ETFE Natural	ea.
F-148	Ferrule for 190 µm OD tubing	10-32 Coned	6,000 psi (414 bar)	—	PCTFE Natural	ea.
F-151	Ferrule for 360 µm OD Tubing	10-32 Coned	6,000 psi (414 bar)	—	PCTFE Natural	ea.
M-215	Conductive Ferrule for 360 µm OD tubing	10-32 Coned	1,500 psi (103 bar)	—	Conductive Perfluoroelastomer	ea.



Two-Piece SealTight™ Fingertight Fittings

- › Several nut lengths and head styles to fit into a variety of applications
- › Designed to connect 1/16" OD tubing to 10-32 coned ports
- › Hold up to 9,000 psi (620 bar)

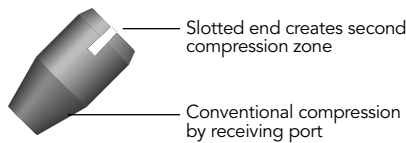

NOTE

Overtightening these fittings on fluoropolymer (e.g., FEP, PFA, and ETFE) tubing can cause the ID of your tubing to collapse.

RELATED PRODUCTS

- › Find tightening tools for these fittings on page 50.
- › Try the F-350x FlushNut™ for the ultimate streamline design.

The dual compression created by the specially designed nut and ferrule enables our SealTight™ Fittings system to outperform standard finger tightened fittings. The forward cone of the SealTight Ferrule provides gripping power and a leak-free seal via conventional compression by the receiving port. The slotted end creates the second compression zone in conjunction with a SealTight Nut. All SealTight Nuts are for use with 1/16" OD tubing and are designed to be used with the F-192x Ferrule. A wide variety of fitting head styles are available for various space constraints.

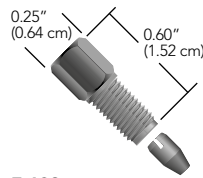

F-193x
10-32 Short PEEK Hex Head Nut, with F-192x Ferrule

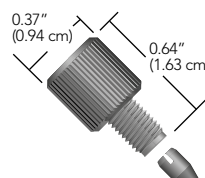

F-195x
10-32 Short PEEK Nut, with F-192x Ferrule

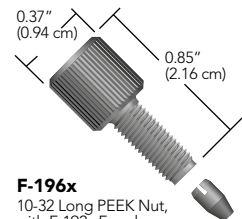

F-196x
10-32 Long PEEK Nut, with F-192x Ferrule

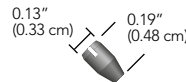

F-192x
SealTight Ferrule, for 1/16" OD tubing

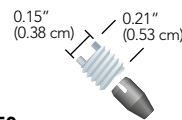

F-350x
10-32 Stainless Steel FlushNut, with F-192x Ferrule

Part No.	Description	Port	Pressure Rating	Head Style	Material	Qty.
SEALTIGHT TWO-PIECE FITTINGS (INCLUDES F-192 FERRULES)						
F-193x	SealTight Fitting for 1/16" OD Tubing, Short	10-32 Coned	7,000–9,000 psi (483–620 bar)	1/4" Hex	PEEK Black	10-pk
F-195x	SealTight Fitting for 1/16" OD Tubing, Short	10-32 Coned	7,000–9,000 psi (483–620 bar)	Standard Knurl	PEEK Black	10-pk
F-196x	SealTight Fitting for 1/16" OD Tubing, Long	10-32 Coned	7,000–9,000 psi (483–620 bar)	Standard Knurl	PEEK Black	10-pk
F-287x	SealTight Fitting for 1/16" OD Tubing, Long	10-32 Coned	7,000–9,000 psi (483–620 bar)	Knurl-1/4" Hex	PEEK Black	10-pk
F-350x	SealTight Fitting for 1/16" OD Tubing, FlushNut	10-32 Coned	7,000–9,000 psi (483–620 bar)	FlushNut	SST	10-pk
REPLACEMENT FERRULES						
F-192x	SealTight Ferrule for 1/16" OD Tubing	10-32 or M6 Coned	7,000–9,000 (483–620 bar)	—	PEEK/Black	10-pk



NanoTight™ Fittings & Sleeves

- › For connecting 1/16" OD or capillary tubing using tubing sleeves to standard 10-32 coned ports
- › Multiple nut styles available
- › Nuts manufactured from PEEK polymer, ferrules manufactured from ETFE



RELATED PRODUCTS

- › Find tightening tools for these head styles on page 50.
- › NanoTight Tubing sleeves start on page 52.

NanoTight™ Fittings and Sleeves are designed to connect 70 µm–1 mm OD capillary tubing to any standard 10-32 coned port normally intended for 1/16" OD tubing using the NanoTight Tubing Sleeves on page 52. The fittings can also be used to connect any 1/16" OD tubing. The ETFE ferrule material is softer than PEEK, making it a good candidate for connecting thin walled semi-rigid tubing such as FEP and ETFE into 10-32 ports with minimal constricting to the inner diameter.

Select from our expansive line of PEEK NanoTight Fittings, featuring several head style and length options. Each 10-pack of nuts includes ten ETFE F-142Nx ferrules.

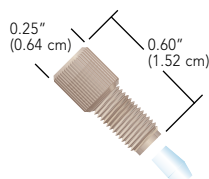

F-333Nx
Short Headless Nut
with F-142Nx Ferrule

Part No.	Description	Port	Pressure Rating	Head Style	Material (Nut/Ferrule)	Qty.
NANOTIGHT FITTINGS (INCLUDES F-142N FERRULES)						
F-333Nx	NanoTight Fitting for 1/16" OD Tubing and NanoTight Sleeves, Short	10-32 Coned	4,000 psi (276 bar)	Headless Knurl	PEEK Natural/ETFE Natural	10-pk
REPLACEMENT FERRULES						
F-142Nx	NanoTight Ferrule for 1/16" OD Tubing and NanoTight Sleeves	10-32 Coned	4,000 psi (276 bar)	—	ETFE Natural	10-pk

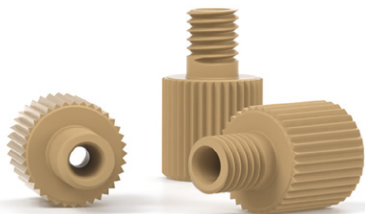

LiteTouch® Fittings

- › Helps prevent twisting of polymer tubing
- › High pressure with fingertight convenience
- › Options available for 1/32", 1/16", or 1/8" OD tubing

LITETOUCH FITTINGS SYSTEMS

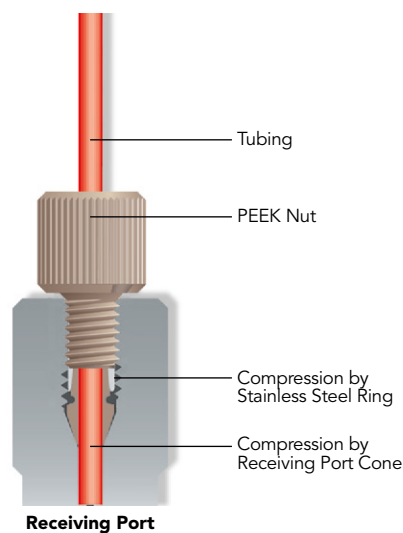

The LiteTouch® Fittings System grips tubing at two compression points (see diagram), holding to high pressures with Fingertight convenience. It also prevents polymer tubing from twisting, a potential problem when using standard Fingertight fittings. LiteTouch Fittings are available for use with 1/32", 1/16", or 1/8" OD tubing sizes, and for 10-32 or 1/4-28 coned ports.

For those space-limited applications where nut heads interfere with each other, try the FlushNut™ Fittings. (FlushNut Fittings require a tightening tool. Please see page 50 for more information about these products.)

To avoid collapsing the ID of your tubing, the LiteTouch system can be used on hard tubing only, such as stainless steel and PEEK polymer tubing. The LiteTouch Ferrule System is not recommended for repeated use in plastic ports.

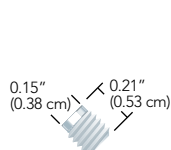

F-354x
10-32 Stainless Steel FlushNut for 1/32" and 1/16" OD tubing

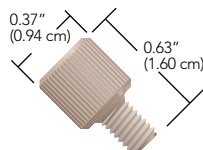

LT-110x
10-32 PEEK Nut for 1/32" and 1/16" OD tubing

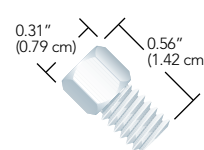

C-235x
1/4-28 Stainless Steel Nut for 1/8" OD tubing

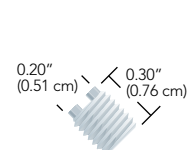

F-364x
1/4-28 Stainless Steel FlushNut for 1/8" OD tubing

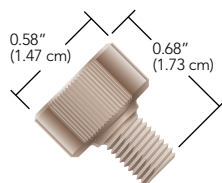

LT-210x
1/4-28 PEEK Double-Winged Nut for 1/8" OD tubing



LT-132x
PEEK Ferrule with Stainless Steel Lock Ring for 1/32" OD tubing



LT-100x
PEEK Ferrule with Stainless Steel Lock Ring for 1/16" OD tubing

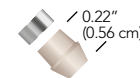

LT-200x
PEEK Ferrule with Stainless Steel Lock Ring for 1/8" OD tubing

RELATED PRODUCTS

- › The stainless steel nuts on page 59 can also be used with the LiteTouch ferrules on this page.

Part No.	Description	Port	Pressure Rating	Head Style	Material	Qty.
LITETOUCH NUTS						
C-235x	LiteTouch Nut for 1/8" OD Tubing	1/4-28 Coned	4,500 psi (310 bar)	5/16" Hex	SST	10-pk
F-354x	LiteTouch Nut for 1/16" or 1/32" OD Tubing, FlushNut	10-32 Coned	5,000 psi (345 bar)	FlushNut	SST	10-pk
F-364x	LiteTouch Nut for 1/8" OD Tubing, FlushNut	1/4-28 Coned	4,500 psi (310 bar)	FlushNut	SST	10-pk
LT-110x	LiteTouch Nut for 1/16" or 1/32" OD Tubing	10-32 Coned	5,000 psi (345 bar)	Standard Knurl	PEEK Natural	10-pk
LT-210x	LiteTouch Nut for 1/8" OD Tubing	1/4-28 Coned	4,500 psi (310 bar)	Double Wing	PEEK Natural	10-pk
LITETOUCH FERRULES						
LT-100x	LiteTouch Ferrule for 1/16" OD Tubing	10-32 Coned	5,000 psi (345 bar)	—	PEEK Natural/SST	10-pk
LT-132x	LiteTouch Ferrule for 1/32" OD Tubing	10-32 Coned	5,000 psi (345 bar)	—	PEEK Natural/SST	10-pk
LT-200x	LiteTouch Ferrule for 1/8" OD Tubing	1/4-28 Coned	4,500 psi (310 bar)	—	PEEK Natural/SST	10-pk

* When used with a stainless steel 10-32 nut from page 59.



Super Flangeless™ Fittings

- › Highest pressure holding flat-bottom fitting system we offer
- › Eliminates loosening of fittings due to tubing twist
- › Excellent for Tubing Assemblies
- › Holds tight even through vibration

★ ASSEMBLY HINT

Make sure the locking ring is oriented correctly! The flattened end of the ring should face towards the nut with the narrow end of the ferrule towards the ring.

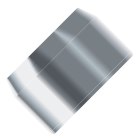

Enlarged to show detail

📄 SUPER FLANGELESS FITTINGS SYSTEM

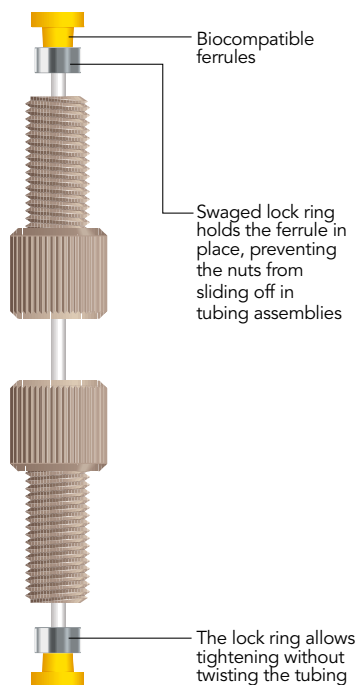

Our Super Flangeless™ Fittings provide the highest pressure holding capability in a flat-bottom fitting system that we offer. Our unique design eliminates loosening of fittings due to tubing twist and holds tight even through vibration. Our high pressure fittings are excellent for tubing assemblies and those times when connections need to be broken frequently.

6-40 & 6-32 options (for 1-16" OD tubing)

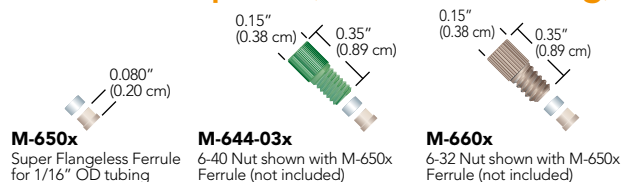

10-32 options (for 1-16" OD tubing)

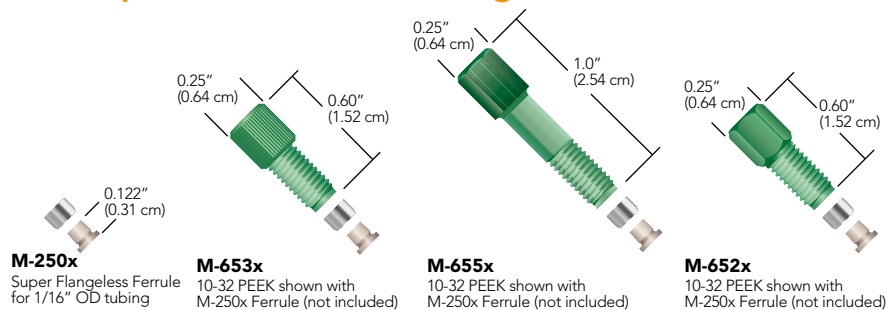

Ferrules for M6x1, 1/4-28, 5/16-24

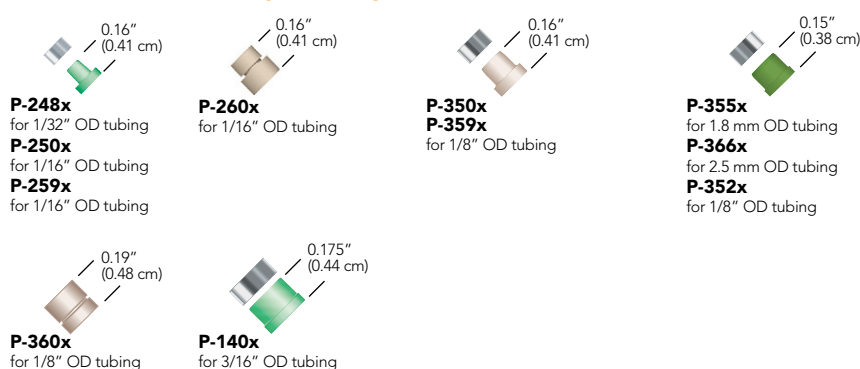

Super Flangeless™ Fittings (Cont.)

M6x1, 1/4-28, 5/16-24 Options for 1/32"–3/16" OD Tubing

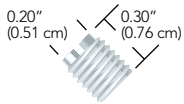

F-356x
(1/4-28, ≤ 1/16" OD Tubing)
F-364x
(1/4-28, > 1/16" OD Tubing)

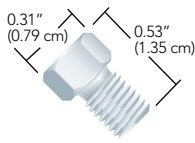

LT-105x
(1/4-28, ≤ 1/16" OD Tubing)
C-235x
(1/4-28, > 1/16" OD Tubing)

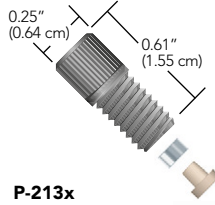

P-213x
(M6X1, ≤ 1/16" OD Tubing)
P-337x
(M6X1, > 1/16" OD Tubing)
P-232x
(1/4-28, ≤ 1/16" OD Tubing)
P-336x
(1/4-28, > 1/16" OD Tubing)

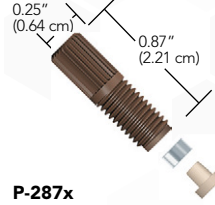

P-287x
(1/4-28, ≤ 1/16" OD Tubing)
P-387x
(1/4-28, > 1/16" OD Tubing)

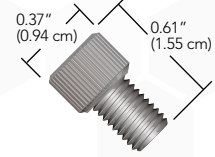

P-219x
(M6X1, ≤ 1/16" OD Tubing)
P-319x
(M6X1, > 1/16" OD Tubing)
LT-115x
(1/4-28, ≤ 1/16" OD Tubing)

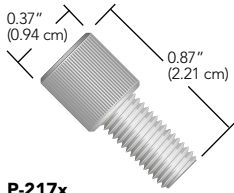

P-217x
(M6X1, ≤ 1/16" OD Tubing)
P-317x
(M6X1, > 1/16" OD Tubing)
P-246x, P-255x, P-281x
(1/4-28, ≤ 1/16" OD Tubing)
P-331x, P-381x
(1/4-28, > 1/16" OD Tubing)

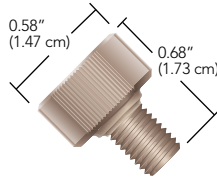

LT-210x
(1/4-28, > 1/16" OD Tubing)

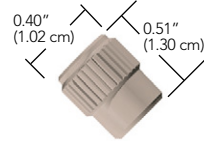

P-420x
(1/4-28, ≤ 1/16" OD Tubing)
F-156x
(1/4-28, > 1/16" OD Tubing)

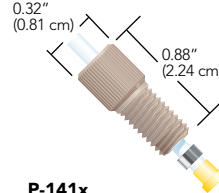

P-141x
(5/16-24, ≤ 1/16" OD Tubing)
P-137x
(5/16-24, 3/16" OD Tubing)

One-Piece Super Flangeless™ Fittings

- › All-PEEK construction
- › For 1/16" OD and 1/8" OD tubing
- › M6x1 and 1/4-28 options
- › Finger tight (2–3 in-lbs / 0.23–0.34 N·m)
- › Extremely easy to use
- › Reusable one piece design that requires no swaging

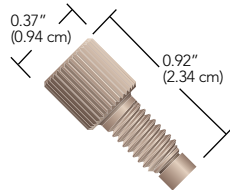

P-329x
M6X1, for 1/8" OD Tubing
P-249x
1/4-28, for 1/16" OD Tubing
P-349x
1/4-28, for 1/8" OD Tubing

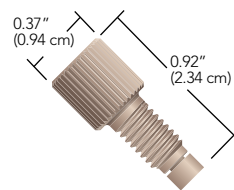

P-229x
M6X1, for 1/16" OD Tubing

Super Flangeless Tubing OD / Thread Comparison

	1/32"	1/16"	1.8 MM	2.5 MM	1/8"	3/16"
6-40		✓				
6-32		✓				
10-32		✓				
M6x1	✓	✓	✓	✓	✓	
1/4-28	✓	✓	✓	✓	✓	
5/16-24						✓

Super Flangeless™ and One-Piece Super Flangeless Fittings

Part No.	Description	Port	Pressure Rating	Head Style	Material	Qty.
SUPER FLANGELESS FERRULES FOR 1/32", 1/16", 1/8", 3/16", 1.8MM, 2.0MM, 2.5MM						
M-250x	Super Flangeless Ferrule for 1/16" OD Tubing	10-32 Flat-Bottom	1,000–5,000 psi (69–345 bar)	—	PEEK Natural/SST	10-pk
M-650x	Super Flangeless Ferrule for 1/16" OD Tubing	6-32 or 6-40 Flat Bottom	750–3,750 psi (52–259 bar)	—	PEEK Natural/SST	10-pk
P-248x	Super Flangeless Ferrule for 1/32" OD Tubing	10-32 Flat-Bottom	2,500 psi (172 bar)	—	ETFE Green/SST	10-pk
P-250x	Super Flangeless Ferrule for 1/16" OD Tubing	1/4-28 or M6 Flat Bottom	2,500 psi (172 bar)	—	PEEK Natural/SST	10-pk
P-259x	Super Flangeless Ferrule for 1/16" OD Tubing	1/4-28 or M6 Flat Bottom	1,350 psi (93 bar)	—	ETFE Yellow/SST	10-pk
P-260x	Super Flangeless Ferrule for 1/16" OD Tubing	1/4-28 or M6 Flat Bottom	1,850 psi (128 bar)	—	PEEK Natural/SST	10-pk
P-350x	Super Flangeless Ferrule for 1/8" OD Tubing	1/4-28 Flat Bottom	2,500 psi (172 bar)	—	PEEK Natural/SST	10-pk
P-352x	Super Flangeless Ferrule for 1/16" OD Tubing	1/4-28 or M6 Flat Bottom	2,500 psi (172 bar)	—	PEEK Black/SST	10-pk
P-355x	Super Flangeless Ferrule for 1.8 mm OD Tubing	1/4-28 or M6 Flat Bottom	2,500 psi (172 bar)	—	PCTFE Green/SST	10-pk
P-357-2x	Super Flangeless Ferrule for 2.0 mm OD Tubing	M6 Flat Bottom	5,000 psi (345 bar)	—	PEEK Natural/SST	10-pk
P-359x	Super Flangeless Ferrule for 1/8" OD Tubing	1/4-28 Flat Bottom	1,000 psi (69 bar)	—	ETFE Yellow/SST	10-pk
P-360x	Super Flangeless Ferrule for 1/8" OD Tubing	1/4-28 Flat Bottom	1,500 psi (102 bar)	—	PEEK Natural/SST	10-pk
P-366x	Super Flangeless Ferrule for 2.5" OD Tubing	1/4-28 Flat Bottom	1,000 psi (69 bar)	—	PEEK Natural/SST	10-pk
P-140x	Super Flangeless Ferrule for 3/16" OD Tubing	5/16-24 Flat Bottom	500 psi (34 bar)	—	ETFE Green/SST	10-pk
6-40 AND 6-32 FITTINGS FOR 1/16" OD TUBING						
M-660x	Super Flangeless Nut for 1/16" OD Tubing	6-32 Flat Bottom	750–3,750 psi (52–259 bar)	Micro Headless	PEEK Natural	10-pk
M-644-03x	Super Flangeless Nut for 1/16" OD Tubing	6-40 Flat Bottom	750–3,750 psi (52–259 bar)	Micro Headless	PEEK Green	10-pk
10-32 FITTINGS FOR 1/16" OD TUBING						
M-652x	Super Flangeless Nut for 1/16" OD Tubing	10-32 Flat Bottom	1,000–5,000 psi (69–345 bar)	1/4" Hex	PEEK Green	10-pk
M-653x	Super Flangeless Nut for 1/16" OD Tubing	10-32 Flat Bottom	1,000–5,000 psi (69–345 bar)	Headless Knurl	PEEK Green	10-pk
M-655x	Super Flangeless Nut for 1/16" OD Tubing, Long	10-32 Flat Bottom	1,000–5,000 psi (69–345 bar)	1/4" Hex	PEEK Green	10-pk
M6X1 FITTINGS FOR 1/16" AND 1/32" OD TUBING						
P-213x	Super Flangeless Nut for 1/16" or 1/32" OD Tubing, Short	M6 Flat Bottom	*	Headless Knurl	PEEK Black	10-pk
P-217x	Super Flangeless Nut for 1/16" or 1/32" OD Tubing	M6 Flat Bottom	*	Standard Knurl	PPS Black	10-pk
P-219x	Super Flangeless Nut for 1/16" or 1/32" OD Tubing, Short	M6 Flat Bottom	*	Standard Knurl	PEEK Black	10-pk
M6X1 FITTINGS FOR 1.8 MM, 2.0 MM, 2.5 MM, 1/8" OD TUBING						
P-317x	Super Flangeless For >1/16"–≤ 1/8" OD Tubing	M6 Flat Bottom	*	Standard Knurl	PPS Black	10-pk
P-319x	Super Flangeless Nut for 1/8" OD Tubing, Short	M6 Flat Bottom	*	Standard Knurl	PEEK Black	10-pk
P-337x	Super Flangeless For >1/16"–≤ 1/8" OD Tubing, Short	M6 Flat Bottom	*	Headless Knurl	PEEK Black	10-pk
P-357x	Super Flangeless Fitting for 2.0 mm OD Tubing	M6 Flat Bottom	*	Standard Knurl	PEEK Black, Natural/SST	10-pk
1/4-28 FITTINGS FOR 1/16" AND 1/32" OD TUBING						
F-356x	Super Flangeless Nut for 1/16" or 1/32" OD Tubing, FlushNut	1/4-28 Flat Bottom	*	FlushNut	SST	10-pk
LT-105x	Super Flangeless Nut for 1/16" or 1/32" OD Tubing, Short	1/4-28 Flat Bottom	*	1/4" Hex	SST	10-pk
LT-115x	Super Flangeless Nut for 1/16" or 1/32" OD Tubing, Short	1/4-28 Flat Bottom	*	Standard Knurl	PEEK Natural	10-pk
P-232x	Super Flangeless Nut for 1/16" or 1/32" OD Tubing, Short	1/4-28 Flat Bottom	*	Headless Knurl	PEEK Natural	10-pk
P-246x	Super Flangeless Nut for 1/16" or 1/32" OD Tubing	1/4-28 Flat Bottom	*	Standard Knurl	PFA Natural	10-pk
P-255x	Super Flangeless Nut for 1/16" or 1/32" OD Tubing	1/4-28 Flat Bottom	*	Standard Knurl	PEEK Natural	10-pk
P-281x	Super Flangeless Nut for 1/16" or 1/32" OD Tubing	1/4-28 Flat Bottom	*	Standard Knurl	PPS Natural	10-pk
P-287x	Super Flangeless Nut for 1/16" or 1/32" OD Tubing	1/4-28 Flat Bottom	*	Headless Knurl	PPS Natural	10-pk
P-420x	Super Flangeless Nut for 1/16" or 1/32" OD Tubing, Female	1/4-28 Flat Bottom	*	Female Knurl	PEEK Natural	10-pk
1/4-28 FITTINGS FOR 1.8MM, 2.5 MM, 1/8" OD TUBING						
C-235x	Super Flangeless Nut for 1/8" OD Tubing	1/4-28 Flat Bottom	*	1/4" Hex	SST	10-pk
F-156x	Super Flangeless Nut for 1/8" OD Tubing, Female	1/4-28 Flat Bottom	*	Female Knurl	PEEK Black	10-pk
F-364x	Super Flangeless Nut for 1/8" OD Tubing, FlushNut™	1/4-28 Flat Bottom	*	FlushNut	SST	10-pk
LT-210x	Super Flangeless Nut for 1/8" OD Tubing	1/4-28 Flat Bottom	*	Double Wings	PEEK Natural	10-pk
P-331x	Super Flangeless Nut for 1/8" OD Tubing	1/4-28 Flat Bottom	*	Standard Knurl	PEEK Natural	10-pk
P-336x	Super Flangeless Nut for 1/8" OD Tubing, Short	1/4-28 Flat Bottom	*	Headless Knurl	PEEK Natural	10-pk
P-381x	Super Flangeless Nut for 1/8" OD Tubing	1/4-28 Flat Bottom	*	Standard Knurl	PPS Natural	10-pk
P-387x	Super Flangeless Nut for 1/8" OD Tubing	1/4-28 Flat Bottom	*	Standard Knurl	PPS Natural	10-pk
5/16-24 FITTINGS FOR 1/16", 1/8", 3/16" OD TUBING						
P-137x	Super Flangeless Fitting for 3/16" OD Tubing	5/16-24 Flat Bottom	*	Standard Knurl	PEEK Black	10-pk
P-141x	Super Flangeless Fitting for 1/16" OD Tubing	5/16-24 Flat Bottom	*	Standard Knurl	PEEK Natural	10-pk
ONE-PIECE SUPER FLANGELESS FITTINGS FOR 1/16" AND 1/8" OD TUBING						
P-229x	One Piece Super Flangeless Fitting for 1/16" OD Tubing	M6 Flat Bottom	1,000 psi (69 bar)	Standard Knurl	PEEK	10-pk
P-249x	One Piece Super Flangeless Fitting for 1/16" OD Tubing	1/4-28 Flat Bottom	1,000 psi (69 bar)	Standard Knurl	PEEK	10-pk
P-329x	One Piece Super Flangeless Fitting for 1/16" OD Tubing	M6 Flat Bottom	1,000 psi (69 bar)	Standard Knurl	PEEK	10-pk
P-349x	One Piece Super Flangeless Fitting for 1/16" OD Tubing	1/4-28 Flat Bottom	1,000 psi (69 bar)	Standard Knurl	PEEK	10-pk

* Pressure rating of nut depends on the ferrule used.



VacuTight™ Fittings

- › For 1/16" or 1/8" OD tubing connections into 10-32, 1/4-28, or M6 flat-bottom ports
- › Vacuum Rated to 25 in-Hg (84 kPa)
- › Improve transfer volume consistency

VacuTight Fittings are designed to provide airtight, dependable connections under vacuum and low pressure conditions. Many of the VacuTight Nuts have streamlined profiles for use in systems requiring a large number of connections in a small area. Furthermore, the VacuTight Ferrule's small size ensures sufficient nut/thread engagement, even in shallow ports. These features make VacuTight Fittings ideal for "combi chem" high throughput screening, clinical diagnostic, and other automated liquid handling applications.

The configuration of the VacuTight flat-bottom ferrules prevents overcompression and tubing ID reduction that can occur with many coned fittings. The result is more consistent aspirating and dispensing volumes across all system connections.

The VacuTight fittings can also work well in some positive pressure applications. The pressure range for each fitting is listed below and depends upon the tubing used for the connection. Please contact your distributor or IDEX Health & Science for more information. Additionally, please note that some of the VacuTight fittings have changed in color from red to black; however, this color change does not affect product performance.

All VacuTight Nuts must be used exclusively with VacuTight Ferrules.

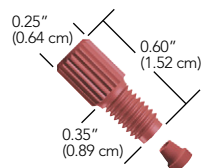

P-844x
PEEK Nut, 10-32
with P-840 Ferrule



P-846x
PEEK Nut, 10-32
with P-840 Ferrule

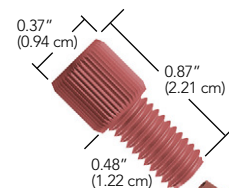

P-930x¹
Delrin® Nut, 1/4-28
with P-840 Ferrule

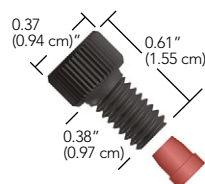

P-945x²
Delrin Nut, M6
with P-940 Ferrule

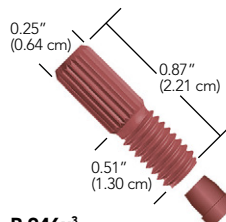

P-946x³
Delrin Nut, 1/4-28
with P-940 Ferrule

¹ The dimensions shown apply to P-930x, P-931x, P-938x, P-942x, and P-948x.

² The dimensions shown apply to P-945x.

³ The dimensions shown apply to P-946x.

Part No.	Description	Port	Pressure Rating	Head Style	Material	Qty.
VACUTIGHT FITTINGS (INCLUDES P-840 OR P-940 FERRULES)						
P-842x	VacuTight Fitting for 1/16" OD Tubing, Short	10-32 Flat-Bottom	400–800 psi (27–55 bar)	1/4" Hex	PEEK Red	10-pk
P-844x	VacuTight Fitting for 1/16" OD Tubing, Short	10-32 Flat-Bottom	400–800 psi (27–55 bar)	Headless Knurl	PEEK Red	10-pk
P-846x	VacuTight Fitting for 1/16" OD Tubing, Long	10-32 Flat-Bottom	400–800 psi (27–55 bar)	Headless Knurl	PEEK Red	10-pk
P-930x	VacuTight Fitting for 1/16" OD Tubing	1/4-28 Flat-Bottom	400–800 psi (27–55 bar)	Standard Knurl	Delrin Red	10-pk
P-931x	VacuTight Fitting for 1/16" OD Tubing	M6 Flat-Bottom	400–800 psi (27–55 bar)	Standard Knurl	Delrin Red	10-pk
P-938x	VacuTight Fitting for 1/16" OD Tubing	1/4-28 Flat-Bottom	400–800 psi (27–55 bar)	Standard Knurl	PEEK Natural	10-pk
P-942x	VacuTight Fitting for 1/8" OD Tubing	1/4-28 Flat-Bottom	500–1,000 psi (34–69 bar)	Standard Knurl	Delrin Red	10-pk
P-945x	VacuTight Fitting for 1/8" OD Tubing, Short	M6 Flat-Bottom	500–1,000 psi (34–69 bar)	Standard Knurl	Delrin Black	10-pk
P-946x	VacuTight Fitting for 1/8" OD Tubing	1/4-28 Flat-Bottom	500–1,000 psi (34–69 bar)	Headless Knurl	Delrin Red	10-pk
P-948x	VacuTight Fitting for 1/8" OD Tubing	1/4-28 Flat-Bottom	500–1,000 psi (34–69 bar)	Standard Knurl	PEEK Natural	10-pk
REPLACEMENT FERRULES						
P-840	VacuTight Ferrule for 1/16" OD Tubing	M6 or 1/4-28 Flat-Bottom	400–800 psi (27–55 bar)	—	ETFE Red	ea.
P-940x	VacuTight Ferrule for 1/8" OD Tubing	M6 or 1/4-28 Flat-Bottom	500–1,000 psi (34–69 bar)	—	ETFE Red	10-pk

Metric Flangeless Fittings

- › For 1/16", 1.8 mm, 2.0 mm, 2.5 mm, 3.0 mm, 4.0 mm, or 1/8" OD tubing
- › Convenience of flangeless fittings for metric tubing sizes and M6 flat-bottom ports

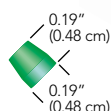

P-342x
ETFE Ferrule
for 1.8 OD tubing

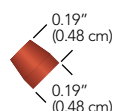

P-363Rx
ETFE Ferrule
for 2.0 mm OD tubing

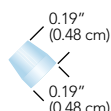

P-353x
ETFE Ferrule
for 2.5 mm OD tubing

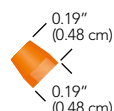

P-343x
ETFE Ferrule
for 3.0 mm OD tubing

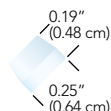

P-344x
ETFE Ferrule
for 4.0 mm OD tubing

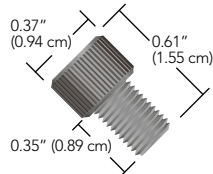

P-347x
PEEK Nut
for 1.8, 2.0, 3.0 mm or
1/8" OD tubing

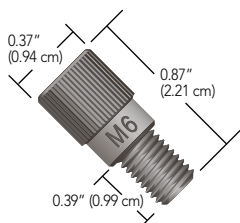

P-207x
Delrin® Nut
for 1/16" OD tubing

Metric Flangeless Ferrules are designed to connect 1.8, 2.0, 2.5, 3.0, or 4.0 mm OD tubing to flat-bottom ports when paired with the appropriate M6, 1/4-28, or 5/16-24 Flangeless Nuts. We also offer M6-threaded nuts to connect 1/16" or 1/8" OD tubing, plus a tubing sleeve to facilitate 1.0 mm OD tubing connections. Please refer to the "Metric Connections" chart on this page for information regarding which nuts and ferrules to use with your tubing.



METRIC CONNECTIONS

Use this chart to determine the low pressure fittings needed to connect metric and English-sized tubing into the indicated ports.

Tubing Size	Port	Ferrules	Nuts
1.0 mm	M6 1/4-28	P-200x (w/F-252 sleeve, not included) P-200x (w/F-252 sleeve, not included)	P-207x, P-207Sx, P-247x Any 1/4-28 nut for 1/16" OD tubing from page 47
1.8 mm	M6 1/4-28	P-342x P-342x	P-307x, P-307Sx, P-347x Any 1/4-28 nut for 1/8" OD tubing from page 47
2.0 mm	M6 1/4-28	P-363Rx P-363Rx	P-307x, P-307Sx, P-347x Any 1/4-28 nut for 1/8" OD tubing from page 47
2.5 mm	M6 1/4-28	P-353x P-353x	P-307x, P-307Sx, P-347x Any 1/4-28 nut for 1/8" OD tubing from page 47
3.0 mm	M6 1/4-28	P-343x P-343x	P-307x, P-307Sx, P-347x Any 1/4-28 nut for 1/8" OD tubing from page 47
4.0 mm	5/16-24	P-344x	XP-132x from page 56
1/16"	M6 M6	P-200x P-840	P-207x, P-207Sx, P-247x, P-931, page 42
1/8"	M6 M6	P-300x P-940x	P-307x, P-307Sx, P-347x, P-945x, page 42



RELATED PRODUCTS

MORE METRIC-SIZED PRODUCTS	Page	Page
High Pressure Polymer Fittings	58	Low Pressure Unions 84
High Pressure Stainless Steel Fittings	59	Bulkhead Unions 82
Luer Adapters	87	PEEK (1.8 mm OD and Capillary) and Fused Silica Tubing 16
Metric Threaded Adapters	65	PEEKsil™ Tubing 22
External NPT Adapters	66	FEP Tubing (1.0-4.0 mm OD) and PFA Capillary Tubing 26
VacuTight™ Fittings	42	Frit-In-A-Ferrule™ 99
Plugs and Caps	55	

In addition, many of our 1/4-28 threaded Filters, Valves and Flow Control Accessories can be converted to accept 1.8, 2.0, 2.5 and 3.0 mm tubing, using the ferrules listed for 1/4-28 ports in the "Metric Connections" table, this page.

Part No.	Description	Port	Pressure Rating	Head Style	Material	Qty.
METRIC FLANGELESS NUTS						
P-207x	Flangeless Nut for 1/16" OD Tubing	M6 Flat-Bottom	2,000 psi (138 bar)	Standard Knurl	Delrin Black	10-pk
P-2075x	Flangeless Nut for 1/16" OD Tubing, Short	M6 Flat-Bottom	2,000 psi (138 bar)	Standard Knurl	Delrin Black	10-pk
P-247x	Flangeless Nut for 1/16" OD Tubing, Short	M6 Flat-Bottom	2,000 psi (138 bar)	Standard Knurl	PEEK Black	10-pk
P-307x	Flangeless Nut for 1.8 mm, 2.0 mm, 3.0 mm, 1/8" OD Tubing	M6 Flat-Bottom	500 psi (34 bar)	Standard Knurl	Delrin Black	10-pk
P-3075x	Flangeless Nut for 1.8 mm, 2.0 mm, 3.0 mm, 1/8" OD Tubing	M6 Flat-Bottom	500 psi (34 bar)	Standard Knurl	Delrin Black	10-pk
P-347x	Flangeless Nut for 1.8 mm, 2.0 mm, 3.0 mm, 1/8" OD Tubing	M6 Flat-Bottom	500 psi (34 bar)	Standard Knurl	PEEK Black	10-pk
FLANGELESS FERRULES						
F-252x	1/16" OD Tubing Sleeve for 1.0 mm ID Tubing	M6 or 1/4-28 Flat-Bottom	500 psi (34 bar)	—	FEP Purple	10-pk
P-200x	Flangeless Ferrule for 1/16" OD Tubing	M6 or 1/4-28 Flat-Bottom	2,000 psi (138 bar)	—	ETFE Blue	10-pk
P-300x	Flangeless Ferrule for 1/8" OD Tubing	M6 or 1/4-28 Flat-Bottom	500 psi (34 bar)	—	ETFE Yellow	10-pk
P-342x	Flangeless Ferrule for 1.8 mm OD Tubing	M6 or 1/4-28 Flat-Bottom	500 psi (34 bar)	—	ETFE Green	10-pk
P-343x	Flangeless Ferrule for 3.0 mm OD Tubing	M6 or 1/4-28 Flat-Bottom	500 psi (34 bar)	—	ETFE Orange	10-pk
P-344x	Flangeless Ferrule for 4.0 mm OD Tubing	5/16-24	250 psi (17 bar)	—	ETFE Natural	10-pk
P-353x	Flangeless Ferrule for 2.5 mm OD Tubing	M6 or 1/4-28 Flat-Bottom	500 psi (34 bar)	—	ETFE Natural	10-pk
P-363Rx	Flangeless Ferrule for 2.0 mm OD Tubing	M6 or 1/4-28 Flat-Bottom	500 psi (34 bar)	—	ETFE Red	10-pk



Flanged Fittings

- › Fittings for 1/16" or 1/8" OD tubing, supplied with nut and 316 stainless steel washer
- › Multiple head styles and materials available; contact IDEX Health & Science for more information
- › For 1/4-28 and M6 flat-bottom ports
- › Some color options available; call for more information

Flanged Fittings are compatible with most standard 1/4-28 or M6 Flat-Bottom flanged fittings. The Delrin® (acetal resin) nut resists cross threading or loosening during use.

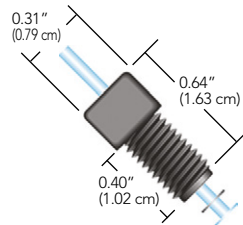

P-401x¹
Flanged Fitting for 1/16" OD tubing*

¹ The dimensions shown apply to all square-head Flanged Fittings

* Flanged tubing not included

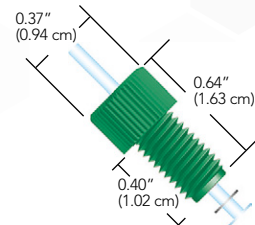

P-482G³
Flanged Fitting for 1/16" OD tubing*

³ The dimensions shown apply to all knurled-head Flanged Fittings

* Flanged tubing not included



RELATED PRODUCTS

- › For an alternative to flanging tubing, we highly recommend the Flangeless Fittings found on page 45, the Super Flangeless™ Fittings found on page 39, or the VacuTight™ Fittings on page 42.

Part No.	Description	Port Geometry	Head Style	Material (Nut/Washer)	Qty.
FLANGED FITTINGS (INCLUDES STAINLESS STEEL WASHERS)					
P-401x	Flanged Fitting for 1/16" OD Tubing	1/4-28 Flat-Bottom	5/16" Square	Delrin Black/SST	10-pk
P-482BLK	Flanged Fitting for 1/16" OD Tubing	1/4-28 Flat-Bottom	Standard Knurl	Delrin Black/SST	ea.
P-501x	Flanged Fitting for 1/8" OD Tubing	1/4-28 Flat-Bottom	5/16" Square	Delrin Black/SST	10-pk
P-982BLKx	Flanged Fitting for 1/16" OD Tubing	M6 Flat-Bottom	Standard Knurl	Delrin Black/SST	10-pk
P-1082BLKx	Flanged Fitting for 1/8" OD Tubing	M6 Flat-Bottom	Standard Knurl	Delrin Black/SST	10-pk
REPLACEMENT WASHERS					
P-407x	Washer for 1/16" OD Tubing	1/4-28 Flat-Bottom	—	SST	10-pk
P-507x	Washer for 1/8" OD Tubing	1/4-28 Flat-Bottom	—	SST	10-pk
P-1087x	Washer for 1/8" OD Tubing	M6 Flat-Bottom	—	SST	10-pk



Flangeless Fittings



THE CONVENIENCE OF FLANGELESS FITTINGS



Our Flangeless Nuts provide fingertight convenience — no wrenches required.

Our Flangeless Ferrules provide a leak-proof seal. There is no need to spend time flanging tubing.

Flangeless Fittings eliminate the need to flange tubing. This removable and reusable system provides several benefits:

Convenience: Flangeless Fittings are easy to use. Just slip the nut and ferrule over the tubing and finger tighten the assembly into your receiving port. In tests, it is shown that the ideal amount of torque to achieve expected part performance should be approximately 3–4 in-lbs (0.34–0.45 N·m). Check out the line of special tightening tools designed to adapt to many standard torque wrenches, on page 50 and the adjustable torque driver, VHP-4000 on page 51.

Minimal Down-Time: Component replacement is quick, taking only a few seconds — unlike the significant time required to flange tubing.

Cost-Effectiveness: Repairing a flanged tubing assembly requires a costly flanging tool or the purchase of a complete replacement assembly, including a new length of tubing and a set of fittings. The Flangeless Fittings system typically requires only one new ferrule at minimal cost when repairing a connection.

The 1/4-28 and M6 Flangeless Fittings for 1/16", 1/8", and metric sized OD tubing are summarized on the following page and listed on page 47.

1/4-28 Flangeless Fittings – Nuts

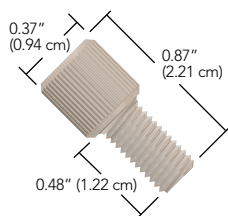

Standard

XP-201x
XP-202x
XP-220x
XP-230x
XP-238x
XP-245x
XP-301x – XP-305x
XP-330x

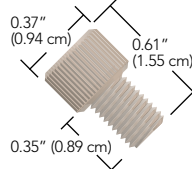

Short

XP-218x
XP-235x
XP-308x
XP-335x
P-207Sx
P-247x
P-307Sx
P-347x

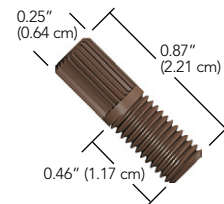

Headless

XP-286x

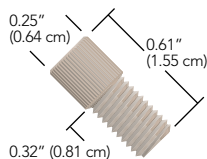

Short Headless

XP-283x

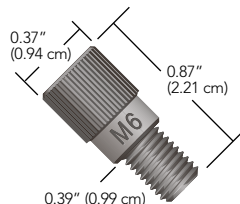

Standard Metric

P-207x
P-307x

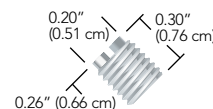

FlushNut™

XF-358x
XF-368x

Flangeless Fittings (Cont.)

NOTE

- › The XP-340x ferrule is designed for use with shallow receiving ports, such as those used on some low pressure valves.



XP-340x
ETFE Small Valve Ferrule

- › The XF-368x FlushNut is an excellent choice for applications where port-to-port spacing is limited; see page 31 for more information on this innovative product line. As an alternative, consider one of the "headless" fittings shown on this page.

Ferrules

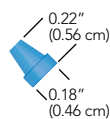

Standard 1/16"
P-200x
XP-200Nx

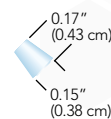

Small Valve 1/16"
XP-240x

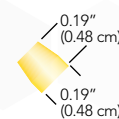

**Standard 1/8"
and Metric Ferrules**
XP-300x
XP-300Nx
P-342x
P-353x
P-363Rx
P-343x

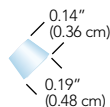

Small Valve 1/8"
XP-340x

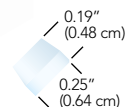

Standard 4.0 mm
P-344x

RELATED PRODUCTS

- › For the Large Bore Flangeless Fittings, please refer to page 56.
- › Nuts for M6 threaded ports are on page 43; nuts for 5/16-24 threaded ports are on page 56.

Flangeless Fittings for 1/16" and 1/8" OD Tubing

- › Wide variety of materials and geometries to fit most applications
- › Excellent replacement for flanged fittings
- › Convenient and easy to use
- › Fittings and ferrules packaged together for easy ordering convenience

Flangeless Fittings for 1/16" OD Tubing, and for 1/8" OD Tubing are available in a variety of materials. The replacement ferrules are manufactured from inert ETFE, and are sold in a colored version or ETFE's natural color as the N option. The smaller ferrules, XP-240x and XP-340x are designed for shallow ports.

The fittings shown on this page are packaged together with the ferrules in convenient 10-packs. The 1/16" version include the XP-200x ferrule, and the 1/8" version include the XP-300x ferrule. Please visit our website, www.idex-hs.com, for single packaging options.

For higher pressure and temperature applications consider our Super Flangeless™ found on page 39.

Lock Nut

The XP-312x Lock Nut is for use with any 1/4-28 male Flangeless Fitting. Use this product in applications where vibrations can loosen fittings.

To Use: Thread the lock nut onto the male fitting. When the male fitting is firmly seated into the receiving port, tighten the lock nut down against the receiving port to securely hold the male fitting in place.



XP-312x
Lock Nut White Delrin

Flangeless Fittings

Part No.	Description	Port	Pressure Rating	Head Style	Material	Qty.
FLANGELESS FITTINGS FOR 1/16" OD TUBING						
XF-358x	Flangeless Fitting for 1/16" OD Tubing, FlushNut	1/4-28 Flat-Bottom	2,000 psi (138 bar)	FlushNut	SST	10-pk
XLT-111x	Flangeless Fitting for 1/16" OD Tubing	10-32 Flat-Bottom	2,500 psi (172 bar)	Standard Knurl	PEEK Natural	10-pk
XP-201x	Flangeless Fitting for 1/16" OD Tubing	1/4-28 Flat-Bottom	2,000 psi (138 bar)	Standard Knurl	Delrin Black	10-pk
XP-202x	Flangeless Fitting for 1/16" OD Tubing	1/4-28 Flat-Bottom	2,000 psi (138 bar)	Standard Knurl	Delrin Red	10-pk
XP-218x	Flangeless Fitting for 1/16" OD Tubing	1/4-28 Flat-Bottom	2,000 psi (138 bar)	Standard Knurl	ETFE Natural	10-pk
XP-230x	Flangeless Fitting for 1/16" OD Tubing	1/4-28 Flat-Bottom	2,000 psi (138 bar)	Standard Knurl	PEEK Natural	10-pk
XP-235x	Flangeless Fitting for 1/16" OD Tubing, Short	1/4-28 Flat-Bottom	2,000 psi (138 bar)	Standard Knurl	PEEK Natural	10-pk
XP-238x	Flangeless Fitting for 1/16" OD Tubing	1/4-28 Flat-Bottom	2,000 psi (138 bar)	Standard Knurl	Delrin Purple	10-pk
XP-245x	Flangeless Fitting for 1/16" OD Tubing	1/4-28 Flat-Bottom	2,000 psi (138 bar)	Standard Knurl	PFA Natural	10-pk
XP-286x	Flangeless Fitting for 1/16" OD Tubing	1/4-28 Flat-Bottom	2,000 psi (138 bar)	Headless Knurl	PPS Natural	10-pk
REPLACEMENT FERRULES FOR 1/16" OD TUBING						
XP-200x	Flangeless Ferrule for 1/16" OD Tubing	1/4-28 Flat-Bottom	2,000 psi (138 bar)	—	ETFE Blue	10-pk
XP-200Nx	Flangeless Ferrule for 1/16" OD Tubing	1/4-28 Flat-Bottom	2,000 psi (138 bar)	—	ETFE Natural	10-pk
XP-240x	Flangeless Ferrule for 1/16" OD Tubing, Small Valve	1/4-28 or 10-32 Flat-Bottom	2,500 psi (172 bar)	—	ETFE Natural	10-pk
FLANGELESS FITTINGS FOR 1/8" OD TUBING (INCLUDES P-300 FERRULES)						
XF-368x	Flangeless Fitting for 1/8" OD Tubing, FlushNut	1/4-28 Flat-Bottom	500 psi (34 bar)	FlushNut	SST	10-pk
XP-301x	Flangeless Fitting for 1/8" OD Tubing	1/4-28 Flat-Bottom	500 psi (34 bar)	Standard Knurl	Delrin Black	10-pk
XP-302x	Flangeless Fitting for 1/8" OD Tubing	1/4-28 Flat-Bottom	500 psi (34 bar)	Standard Knurl	Delrin Red	10-pk
XP-305x	Flangeless Fitting for 1/8" OD Tubing	1/4-28 Flat-Bottom	500 psi (34 bar)	Standard Knurl	Delrin Green	10-pk
XP-308x	Flangeless Fitting for 1/8" OD Tubing, Short	1/4-28 Flat-Bottom	500 psi (34 bar)	Standard Knurl	Delrin Black	10-pk
XP-315x	Flangeless Fitting for 1/8" OD Tubing	1/4-28 Flat-Bottom	500 psi (34 bar)	Standard Knurl	ETFE Natural	10-pk
XP-330x	Flangeless Fitting for 1/8" OD Tubing	1/4-28 Flat-Bottom	500 psi (34 bar)	Standard Knurl	PEEK Natural	10-pk
XP-335x	Flangeless Fitting for 1/8" OD Tubing, Short	1/4-28 Flat-Bottom	500 psi (34 bar)	Standard Knurl	PEEK Natural	10-pk
REPLACEMENT FERRULES FOR 1/8" OD TUBING						
XP-300x	Flangeless Ferrule for 1/8" OD Tubing	1/4-28 Flat-Bottom	500 psi (34 bar)	—	ETFE Yellow	10-pk
XP-300Nx	Flangeless Ferrule for 1/8" OD Tubing	1/4-28 Flat-Bottom	500 psi (34 bar)	—	ETFE Natural	10-pk
XP-340x	Flangeless Ferrule for 1/8" OD Tubing, Small Valve	1/4-28 Flat-Bottom	500 psi (34 bar)	—	ETFE Natural	10-pk
XP-312x	Lock Nut for Flangeless Nuts	1/4-28 Flat-Bottom	—	—	Delrin White	10-pk



- › Finger-tight to 19,000 psi
- › Reusable more than 100 times
- › Zero Dead Volume
- › Biocompatible
- › Limit Wear
- › Increase Product Life
- › Many IDs and Lengths Available

★ LEARN MORE

Learn more about MarvelXact at www.biotechfluidics.com/products/marvelxact/

NOTE

- › MarvelXACT tubing includes a sleeve that assists in product identification, with ID, length and part number information.

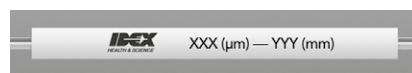

- › Minimum recommended bend-radius with MarvelXACT tubing is 1/4" (~6.35 mm).

MarvelXACT™

Our New MarvelXACT™ Fitting System with a "click" feedback

Ensure a perfect connection every time with our new MarvelXACT™ fitting system for trouble-free liquid chromatography. Our MMarvelXACT™ connection systems have been expertly designed to eliminate the risk of under- or over-tightening with our patented torque limiting mechanism. This unique feature emits a haptic "click" feedback when it reaches the optimum torque, assuring a perfect installation every time. MarvelXACT™ incorporates our advanced MarvelX™ Sealing Technology to deliver precise face sealing (sealing at the port bottom), which eliminates additional internal volume, and minimizes carryover risk, peak tailing, and peak broadening.

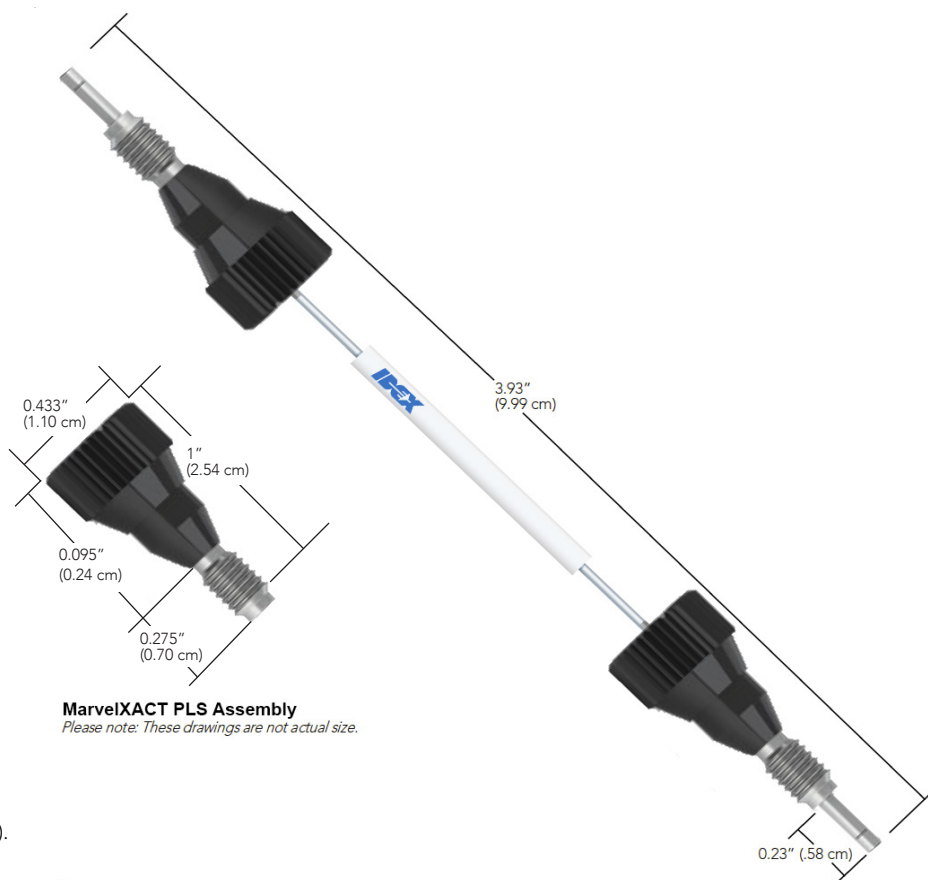

MarvelXACT PLS Assembly
Please note: These drawings are not actual size.

SPECIFICATIONS & DETAILS

Pressure Capability	19,000 psi (~1,310 bar, 131 MPa) for routine use
Installation Method	Finger-tighten until the first "click" feedback is received
Tubing Type	1/32" OD flexible 316 Stainless Steel with 1/16" OD rigid tube ends
Fitting Type	10-32 threaded, PEEK fittings with 316 Stainless Steel threads
Wetted Materials PEEK-Lined versions	PEEK
Stainless Steel versions	PEEK and 316 Stainless Steel
Maximum Use Temperature	120 °C

NOTE: The above performance specifications apply to use with appropriately-designed receiving ports under optimal conditions, using water at up to 120 °C for the testing process. If different conditions are used, the expected pressure threshold will be different.



INSTRUCTIONS FOR TIGHTENING

Finger-tighten until the first "click" feedback is received.



MARVELXACT™ UHPLC FITTINGS VS CONVENTIONAL CONED FITTINGS

Conventional coned fittings require a ferrule in conjunction with a fitting for proper sealing. They depend on complex techniques, including tools, to improve sealing performance, which significantly increases probability of extra internal volume and poor chromatography results. The excessive force needed for tightening increases wear of expensive components and the likelihood of replacement, adding to overall costs.

MarvelXACT™ fittings do not depend on ferrules. They seal at the bottom of the port, without complex techniques, which significantly reduces required torque and enables many more connects and disconnects. MarvelXACT significantly reduces wear on your hardware, increasing product life. An enhanced proprietary tip design also ensures zero dead volume (ZDV) and better chromatography results.

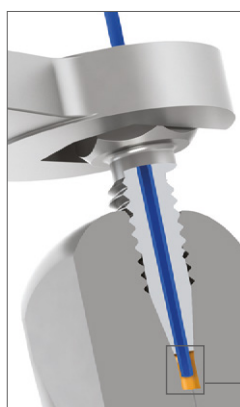

EXTRA
INTERNAL
VOLUME

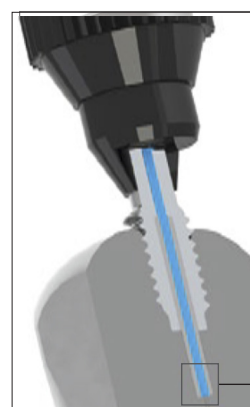

ZERO
DEAD
VOLUME



TECHNICAL SPECIFICATIONS

Length:	150 mm	250 mm	350 mm	500 mm	600 mm
Peek-lined Stainless Steel Assemblies*					
25 µm ID	UPFP-7025150	UPFP-7025250	UPFP-7025350	UPFP-7025500	UPFP-7025600
50 µm ID	UPFP-7050150	UPFP-7050250	UPFP-7050350	UPFP-7050500	UPFP-7050600
75 µm ID	UPFP-7075150	UPFP-7075250	UPFP-7075350	UPFP-7075500	UPFP-7075600
100 µm ID	UPFP-7100150	UPFP-7100250	UPFP-7100350	UPFP-7100500	UPFP-7100600
Stainless Steel Assemblies*					
100 µm ID	UPFS-7100150	UPFS-7100250	UPFS-7100350	UPFS-7100500	UPFS-7100600
125 µm ID	UPFS-7125150	UPFS-7125250	UPFS-7125350	UPFS-7125500	UPFS-7125600
254 µm ID	UPFS-7254150	UPFS-7254250	UPFS-7254350	UPFS-7254500	UPFS-7254600

*Product availability and lead times may vary depending on the configuration.

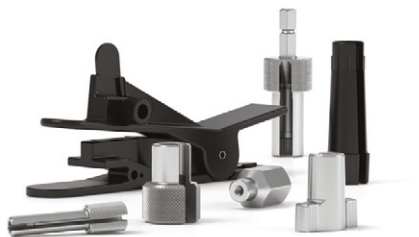

Fittings Tools



VHP-1000
VHP Wrench
1/4 in Hex 10 in-lbs (1.13 N·m)

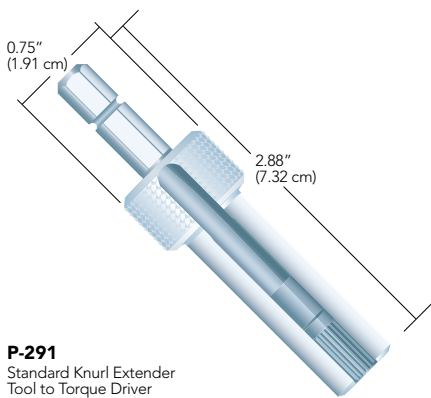

P-291
Standard Knurl Extender
Tool to Torque Driver

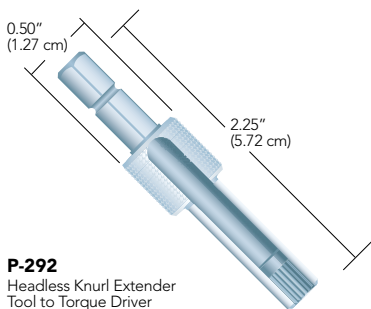

P-292
Headless Knurl Extender
Tool to Torque Driver

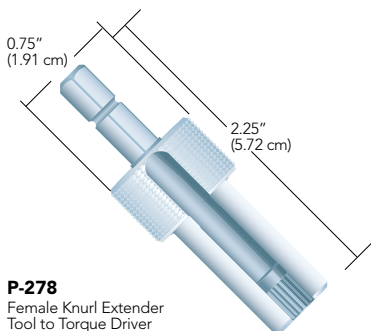

P-278
Female Knurl Extender
Tool to Torque Driver

Tightening Tools for VHP & Other Fittings

- › Configured for the optimum torque to provide assurance of a strong connection
- › Prolongs the lifetime of reusable fittings by not overtightening
- › Available for multiple fitting head styles

This new line of tightening tools is designed for the VHP fittings and can also be used with any fitting in this chapter described to have a corresponding head style to the tool listed below. There are three styles of tightening tools available for various applications. The Torque Tools (VHP-1000 and VHP-2000) are breakaway torque wrenches designed to deliver a precise amount of torque to the fitting system. These torque wrenches come calibrated according to ISO 6789:2003 ($\pm 6\%$ of setting) and have been tested extensively with the reusable VHP fittings on page 60. Choose the appropriate torque delivered and the proper head style to work with the VHP fittings, increasing the ease of use with these fittings.

The VHP-4000 Torque Driver couples with the specially designed Extender Tools listed below and provides an externally adjustable torque setting. This tool along with the appropriate Extender Tools will tighten any IDEX Health & Science knurled polymer fitting in your system. Reference the head style found in the tables at the bottom of each page for information on the proper Extender Tool to select.

Because of the small hex-head on the M4 fittings (VHP-900 and VHP-920), a custom wrench, the VHP-9000, is available in the table at the bottom of the page 51.





Extender Tools

These tools can be used to tighten most of our knurled nuts in hard to reach places. See the application note on this page for knurl size and corresponding extender tool.

For precise tightening, the extender tools listed with 1/4" hex drives are designed to adapt to any torque wrench with a female 1/4" socket, such as the VHP-4000 Torque Driver on page 51. The tools featured on this page also include the FlushNut™ wrenches, used to tighten the FlushNuts found throughout this chapter and described in detail on page 51.

APPLICATION NOTE

The drawings represent actual size of the various knurled head designs of the IDEX Health & Science nuts featured in this chapter. Select the appropriate extender tool for the knurl pattern of the nut you've selected.

FEMALE KNURL	STANDARD KNURL	HEADLESS KNURL
		
STANDARD MICRO KNURL	MICRO HEADLESS KNURL	
		



Removal Tool

Use the LT-300 Removal Tool to detach LiteTouch® and Super Flangeless™ Ferrules from tubing. Simply slide the appropriate tool blade slot between the lock ring and the ferrule body. With a slight twist, the ring will pop off, releasing the ferrule from the tubing. *Please Note: This Removal Tool will not work with the LT-135x Ferrule System.*



Wrenches

For your convenience, we offer wrenches in three standard sizes. You will need two A-304 wrenches to tighten most nuts into unions found on page 36 (for union 1593, you need one A-304 and one A-320 wrench).

The IDEX Wrench is slotted to fit over 1/16" and 1/8" OD tubing, and has 1/4" and 5/16" internal hex ends, to engage with the heads of the hex-head fittings most commonly used with IDEX Health & Science valves and the stainless steel fittings listed on page 59.

Fittings Tools

Part No.	Description	Use With Head Style	Torque Delivered	Qty.
VHP TIGHTENING TOOLS				
F-347	Extender Tool to Torque Driver	FlushNut (1/4-28)	—	ea.
N-291	Extender Tool to Torque Driver	Micro Headless	—	ea.
P-268	Extender Tool to Torque Driver	1/4" Hex	—	ea.
P-278	Extender Tool to Torque Driver	Female Nut Knurl	—	ea.
P-279	Extender Tool to Torque Driver	Micro Nut Knurl	—	ea.
P-291	Extender Tool to Torque Driver	Standard Nut Knurl	—	ea.
P-292	Extender Tool to Torque Driver	Headless Nut Knurl	—	ea.
P-1000	Standard Knurl Torque Tool	Standard Knurl	4 in-lbs (0.45 N-m)	ea.
VHP-1000	VHP Torque Tool	1/4" Hex	10 in-lbs (1.13 N-m)	ea.
VHP-2000	VHP Torque Tool	1/4" Hex	14 in-lbs (1.58 N-m)	ea.
VHP-4000	VHP Torque Driver	Extender Tool 1/4" Drive	Adjustable between 2–12 in-lbs (0.23–1.35 N-m)	ea.
VHP-9000	4 mm Wrench	4 mm Hex	—	ea.
EXTENDER TOOLS				
Part No.	Description	Material		Qty.
P-291	Extender Tool for Standard Head Nuts, with 1/4" Hex Drive	Aluminum		ea.
P-298	Extender Tool for Standard Head Nuts	Delrin®		ea.
P-299	Extender Tool for Standard Head Nuts	Aluminum		ea.
P-399	Extender Tool for Standard Head Nuts, Short	Aluminum		ea.
P-297	Extender Tool for Headless Nuts	Aluminum		ea.
P-292	Extender Tool for Headless Nuts, with 1/4" Hex Drive	Aluminum		ea.
P-277	Extender Tool for Standard Micro Nuts	Aluminum		ea.
N-290	Extender Tool for Micro Headless Nuts	Aluminum		ea.
P-278	Extender Tool for Female Nuts, with 1/4" Hex Drive	Aluminum		ea.
MISCELLANEOUS TOOLS				
A-304	Wrench, 1/4" x 5/16"	Steel		ea.
A-305	Wrench, 1/2" x 9/16"	Steel		ea.
A-320	Wrench, 3/8" x 7/16"	Steel		ea.
6810	IDEX Wrench, 1/4" x 5/16"	Steel		ea.
F-345	FlushNut Wrench for 10-32 Threaded Fittings	Steel/Plastic Handle		ea.
F-346	FlushNut Wrench for 1/4-28 Threaded Fittings	Steel/Plastic Handle		ea.
LT-300	Removal Tool for LiteTouch and Super Flangeless Ferrules	Steel/Plastic Handle		ea.
M-150	Swaging Tool for TinyTight Fittings, for 6–40 MINSTAC Port	SST		ea.



Tubing Sleeves

MicroTight® Tubing Sleeves

- › Manufactured from PEEK polymer
- › Pressure rated to 4,000 psi (276 bar)
- › Color-coded for easy inner diameter identification

IDEX Health & Science MicroTight Tubing Sleeves feature an outer diameter of 0.025" and offer a wide assortment of inner diameters to help facilitate capillary tubing connections with our MicroTight accessories. Because the sleeves are manufactured from PEEK polymer, they carry an upper temperature threshold of 125 °C.

To use these sleeves properly, choose a sleeve with an inner diameter 0.001"–0.002" (25–50 µm) larger than the outer diameter of your capillary tubing. Then, slip the sleeve over your flow path tubing, such that your tubing extends all the way through the sleeve, but not beyond the end of the sleeve. Choose the correct fitting that corresponds with your receiving port, slide it over the sleeved flow path tubing and connect as normal.



NanoTight™ Tubing Sleeves

- › Manufactured from FEP fluoropolymer
- › Pressure rated to 4,000 psi (276 bar)
- › Outer diameter of 1/16" — the most popular size used on most instrumentation

NanoTight Tubing Sleeves are manufactured using FEP fluoropolymer and precisely cut to a 1.6" length. A wide assortment of sleeves is available, ensuring the availability of a NanoTight sleeve for most applications. Many of the sleeves feature a light color tint that can help more easily identify the inner diameter for future orders. Because FEP is the base polymer for these sleeves, there is a maximum recommended continuous operating temperature of 50 °C.

Our NanoTight sleeves were designed primarily for use with the NanoTight fittings, found on page 37 and also work well with the Super Flangeless™ fittings for 1/16" OD tubing on page 39. For tubing sleeves that can be used effectively with stainless steel fittings and at higher temperatures, consider using the PEEK Tubing Sleeves, found below.

1/16" OD PEEK Tubing Sleeves

- › For connecting capillary tubing to standard 10-32 ports
- › Require the use of wrench tightened stainless steel nuts
- › Pressure rated to 6,000 psi (414 bar)

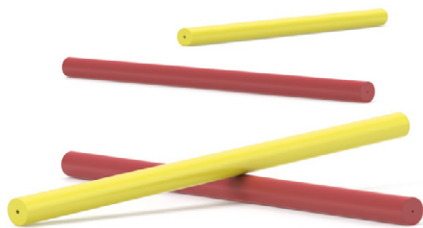

Like the NanoTight™ FEP Sleeves on the previous page, these PEEK Tubing Sleeves are designed to be used with 1/16" OD, 10-32 threaded fittings to adapt capillary tubing to standard coned ports. Made of PEEK polymer, these 1.3" long sleeves can be used up to 125 °C.

These sleeves require a wrench tightened nut to achieve proper sealing. We recommend our SealTight™ fittings on page 36. Many researchers also use a stainless steel nut and ferrule with these sleeves, such as our U-400 and U-401 (page 33).

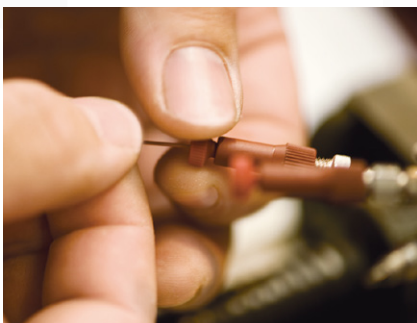

1/32" OD PEEK Tubing Sleeves

These 1.6" long 1/32" OD PEEK Tubing Sleeves can be used with any fitting designed for 1/32" OD tubing when smaller tubing must be connected. Select the appropriate sleeve from the product listing for your capillary tubing OD size. The 1/32" OD PEEK Tubing Sleeves have a maximum recommended temperature of 125 °C and have a pressure rating of 5,000 psi (345 bar).



1/32" OD FEP Tubing Sleeves

These 1.6" long sleeves facilitate connecting capillary tubing into ports designed for 1/32" OD tubing. Please refer to the product listing below to select the appropriate sleeve for your capillary OD size. These sleeves can be used at up to 50 °C and have a pressure rating of 1,750 psi (121 bar).

Clockwise, starting at top:

- › 1/16" OD PEEK Tubing Sleeves, use with U-400 and U-401 (not shown)
- › 1/32" OD FEP Tubing Sleeves, shown with F-126Sx Fitting
- › Fittings and tubing only shown to highlight how sleeves are designed to be used; they are not included with the sleeves



APPLICATION NOTE

Why use Sleeves?

Because most capillary tubing connections are made into coned receiving ports, where the port is not designed to be used with capillary tubing directly, special care must be used to ensure a good connection. While custom ferrules can help make these connections, they only offer a fixed-length nose — and because most tubing pockets will vary slightly in length, this can lead to leaking or dead volume.

To help save overall expense while maintaining a concentric connection with minimal dead volume, IDEX Health & Science recommends the use of sleeves. Because sleeves are not permanently attached to a ferrule, they can easily adapt to varying tubing pocket depths. Additionally, because they are manufactured using extruded polymer tubing, you are assured of the concentricity of the resultant connection.

Tubing Sleeves (Cont.)



RELATED PRODUCTS

Use 1/32" OD PEEK or FEP Sleeves to connect capillary tubing with the following:

- › The F-113 Ferrule and Two-Piece Fingertight Fittings for 10-32 ports (page 35).
- › The F-112 and P-416BLK MicroTight® Fittings (page 34) — 1/32" OD PEEK Tubing Sleeves only.
- › The 1/32" OD MicroTight Fittings on page 34.
- › The RheFlex M4 Fitting (page 61) for MX Module applications; the M-645 Valco®-Compatible Fitting (page 33) for Valco Nanovolume® valve applications.

Tubing Sleeves

Part No.	ID	For Tubing OD Size	Color	Qty.
MICROTIGHT PEEK TUBING SLEEVES AND KITS, 0.025" OD				
F-180	125 µm (0.005")	70–110 µm	Red	ea.
F-181	180 µm (0.007")	125–165 µm	Yellow	ea.
F-182	230 µm (0.009")	175–215 µm	Natural	ea.
F-183	280 µm (0.011")	225–265 µm	Blue	ea.
F-184	330 µm (0.013")	275–315 µm	Orange	ea.
F-185	395 µm (0.0155")	340–380 µm	Green	ea.
F-186	455 µm (0.018")	400–440 µm	Black	ea.
F-187	535 µm (0.021")	480–520 µm	Natural	ea.
F-188	152 µm (0.006")	95–135 µm	Purple	ea.
1328	MicroTight Tubing Sleeve Kit, contains (6) each of the sleeve sizes listed above	—	—	ea.
1356	MicroTight Connector Kit, contains: a 10-pack of each MicroTight Tubing Sleeve (F-180–F-187); (2) P-770 MicroTight Adapters; and (2) MicroTight P-720 Unions	—	—	ea.
NANOTIGHT FEP TUBING SLEEVES, 1/16" OD				
F-237	125 µm (0.005")	70–110 µm	Red	ea.
F-238	180 µm (0.007")	125–165 µm	Yellow	ea.
F-239	215 µm (0.0085")	160–200 µm	Natural	ea.
F-240	280 µm (0.011")	225–265 µm	Blue	ea.
F-241	330 µm (0.013")	275–315 µm	Orange	ea.
F-242	395 µm (0.0155")	340–380 µm	Green	ea.
F-243	455 µm (0.018")	400–440 µm	Black	ea.
F-244	535 µm (0.021")	480–520 µm	Natural	ea.
F-245	610 µm (0.024")	555–595 µm	Red	ea.
F-246	685 µm (0.027")	630–670 µm	Yellow	ea.
F-247	840 µm (0.033")	785–825 µm	Green	ea.
F-252	1.07 mm (0.042")	1 mm	Purple	ea.
PEEK TUBING SLEEVES FOR 1/16" OD FITTINGS				
F-225	125 µm (0.005")	70–110 µm	Red	ea.
F-226	180 µm (0.007")	125–165 µm	Yellow	ea.
F-227	230 µm (0.009")	175–215 µm	Yellow	ea.
F-228	250 µm (0.011")	225–265 µm	Blue	ea.
F-229	330 µm (0.013")	275–315 µm	Natural	ea.
F-230	405 µm (0.016")	350–390 µm	Orange	ea.
F-231	560 µm (0.022")	505–545 µm	Natural	ea.
F-232	785 µm (0.031")	730–770 µm	Natural	ea.
F-233	865 µm (0.034")	785–825 µm	Blue	ea.
F-234	685 µm (0.027")	630–670 µm	Yellow	ea.
PEEK TUBING SLEEVES FOR 1/32" OD FITTINGS				
F-381	180 µm (0.007")	125–165 µm	Yellow	ea.
F-382	205 µm (0.008")	150–190 µm	Natural	ea.
F-384	255 µm (0.010")	200–240 µm	Blue	ea.
F-385	380 µm (0.015")	325–365 µm	Natural	ea.
F-386	510 µm (0.020")	455–495 µm	Orange	ea.
F-387	250 µm (0.011")	225–265 µm	Red	ea.
F-388	330 µm (0.013")	275–315 µm	Black	ea.
FEP TUBING SLEEVES FOR 1/32" OD FITTINGS				
F-374	280 µm (0.011")	225–265 µm	Blue	ea.
F-375	330 µm (0.013")	275–315 µm	Orange	ea.
F-376	395 µm (0.0155")	340–380 µm	Green	ea.



Plugs & Caps

- › Seal 6-32, 6-40, 10-32, 1/4-28, M6, or 5/16-24 threaded ports or fittings

Use our plugs to close off unused ports in valves and multi-port connectors. Our color-coded 10-32 threaded plugs are perfect for identifying stored columns that have different packing materials, or in which different mobile phases have been utilized. Cap off tubing with one of the PEEK or ETFE caps presented on this page and the appropriate fittings from this chapter.

To help determine which plug or cap is best suited for your application, please visit www.idex-hs.com for detailed chemical compatibility data.

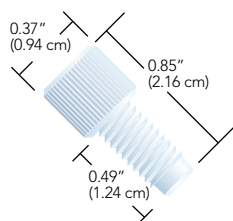

P-316
PFA Plug
for 1/4-28 flat-bottom ports

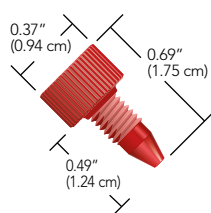

U-467R
Delrin® Column Plug
for 10-32 coned ports

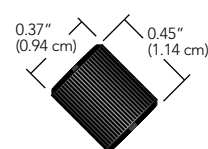

P-755
ETFE Cap
for 1/4-28 flat-bottom fittings

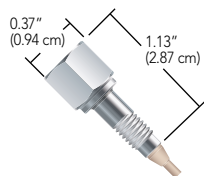

VHP-600
VHP Plug
for 10-32 coned ports

Part No.	Description	Head Style	Material	Qty.
PLUGS				
P-120	Plug for 1/4-28 Coned Ports for 1/8" OD Tubing	Standard Knurl	PCTFE Natural	ea.
P-123	Plug for 1/4-28 Flat-Bottom Ports	5/16" Hex	ETFE Natural	ea.
P-309	Plug for 1/4-28 Flat-Bottom Ports	Standard Knurl	Delrin Black	ea.
P-311	Plug for 1/4-28 Flat-Bottom Ports	Standard Knurl	ETFE Natural	ea.
P-314	Plug for M6 Flat-Bottom Ports	Standard Knurl	ETFE Black	ea.
P-316	Plug for 1/4-28 Flat-Bottom Ports	Standard Knurl	PFA Natural	ea.
P-321	Plug for 1/4-28 Flat-Bottom Ports, FlushNut™	FlushNut	PEEK Natural	ea.
P-520	Plug for 10-32 Coned Ports	5/16" Hex	SST	ea.
P-550	Plug for 10-32 Coned Ports, Extra Long	Standard Knurl	PEEK Natural	ea.
P-551	Plug for 10-32 Coned Ports	Standard Knurl	PEEK Natural	ea.
P-555	Plug for 6-32 Coned Ports	Standard Micro Knurl	PEEK Natural	ea.
P-556	Plug for 5/16-24 Flat-Bottom Ports	Standard Knurl	PEEK Natural	ea.
P-558	Plug for 6-40 Flat-Bottom Ports	Micro Headless Knurl	PEEK Green	ea.
P-849	Plug for 10-32 Flat-Bottom Ports	Standard Knurl	Delrin Black	ea.
U-467R	Plug for 10-32 Coned Ports	Standard Knurl	Delrin Red	ea.
VHP-600	VHP Plug for 10-32 Coned Ports	3/8" Hex	PK-SST	ea.
CAPS				
P-754	Cap for 10-32 Coned Ports	Standard Knurl	ETFE Yellow	ea.
P-755	Cap for 1/4-28 Flat-Bottom Ports	Standard Knurl	ETFE Black	ea.
P-756	Cap for M6 Flat-Bottom Ports	Standard Knurl	ETFE Blue	ea.

Large Bore Fittings

- › 5/16-24 or 1/2-20 threads
- › For use with 1/16", 1/8", 3/16", 1/4", 5/16", 3.0 mm, or 4.0 mm OD tubing

NOTE

Each of the Large Bore Fittings shown on this page comes in a convenient 10-pack and is packaged with the most popularly chosen Ferrule option. The Fittings can be ordered separately by removing the preceding letter "X" from the part number. Additionally, to connect metric-sized tubing with outer diameters less than 4.0 mm to 5/16-24 threaded ports, reference the chart on page 43 to choose the correct nut/ferrule combination.

RELATED PRODUCTS

	Page
MORE LARGE BORE PRODUCTS	
5/16-24 Coned Fittings	41
Barbed Adapters	90
Threaded Adapters	63
Plugs	55, 112
Y Connector	90
ETFE Tubing	27
FEP, PFA Tubing	26, 24
Tubing Cutter	28
Pressure Relief Valve	148
Solvent Inlet Filters	102
Bottle Caps	55
Semi-Prep Inline Filters	107

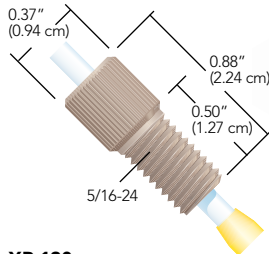

XP-130x
PEEK Nut, for 1/8" OD tubing shown with P-300 Flangeless Ferrule (page 43)

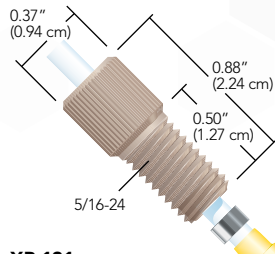

XP-131x
PEEK Nut, for 1/8" OD tubing shown with P-359 Super Flangeless™ Ferrule (included and found on page 41)

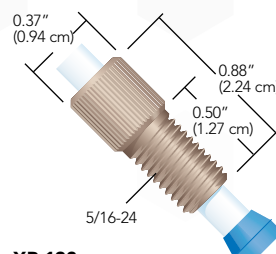

XP-132x
PEEK Nut, for 3/16" and 4.0 mm OD tubing shown with P-133 Flangeless Ferrule (included and found on this page)

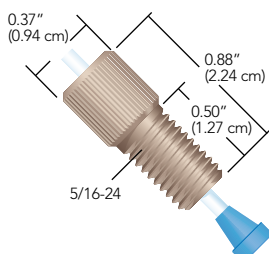

XP-136x
PEEK Nut, for 1/16" OD tubing shown with P-200 Flangeless Ferrule (included and found on page 43)

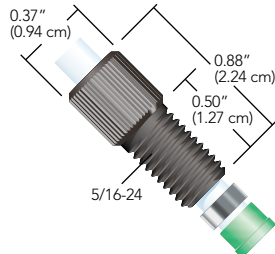

XP-137x
PEEK Nut, for 3/16" OD tubing shown with P-140 Super Flangeless Ferrule (included and found on page 56)

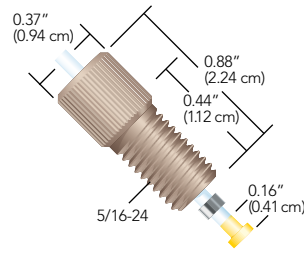

XP-141x
PEEK Nut, for 1/16" OD tubing shown with P-259 Super Flangeless Ferrule (included and found on page 41)

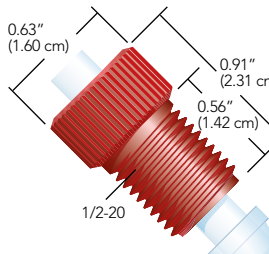

XU-620x
PEEK Nut, for 1/4" OD tubing shown with inverted U-650 Flangeless Ferrule for coned ports (included and found on this page)

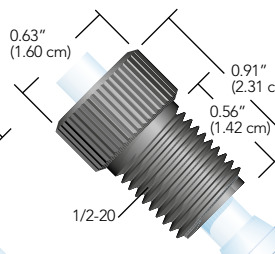

XU-655x
PEEK Nut, for 1/4" OD tubing shown with U-650 Flangeless Ferrule (included and found on this page)

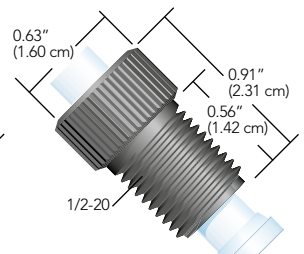

XU-662x
PEEK Nut, for 1/4" OD tubing shown with U-660 Flangeless Ferrule (included and found on this page)

Part No.	Description	Port	Pressure Rating	Head Style	Material (Nut/Washer)	Qty.
LARGE BORE FITTINGS						
XP-130x	Flangeless Fitting for 1/8" OD tubing	5/16-24 Flat-Bottom	500 psi (34 bar)	Standard Knurl	PEEK Natural/ETFE Yellow	10-pk
XP-131x	Super Flangeless Fitting for 1/8" OD tubing	5/16-24 Flat-Bottom	1,000 psi (69 bar)	Standard Knurl	PEEK Natural/ETFE Yellow/SST	10-pk
XP-132x	Flangeless Fitting for 3/16" OD tubing	5/16-24 Flat-Bottom	500 psi (34 bar)	Standard Knurl	PEEK Natural/ETFE Blue	10-pk
XP-136x	Flangeless Fitting for 1/16" OD tubing	5/16-24 Flat-Bottom	2,000 psi (138 bar)	Standard Knurl	PEEK Natural/ETFE Blue	10-pk
XP-137x	Super Flangeless Fitting for 3/16" OD tubing	5/16-24 Flat-Bottom	500 psi (34 bar)	Standard Knurl	PEEK Black/ETFE Green/SST	10-pk
XP-141x	Super Flangeless Fitting for 1/16" OD tubing	5/16-24 Flat-Bottom	1,350 psi (93 bar)	Standard Knurl	PEEK Natural/ETFE Yellow/SST	10-pk
XU-620x	Flangeless Fitting for 1/4" OD tubing	1/2-20 Coned	250 psi (17 bar)	Large Knurl	PEEK Red/ETFE Natural	10-pk
XU-655x	Flangeless Fitting for 1/4" OD tubing	1/2-20 Flat-Bottom	250 psi (17 bar)	Large Knurl	PEEK Black/ETFE Natural	10-pk
XU-662x	Flangeless Fitting for 5/16" OD tubing	1/2-20 Flat-Bottom	250 psi (17 bar)	Large Knurl	PEEK Black/ETFE Natural	10-pk
REPLACEMENT FERRULES						
P-133x	Flangeless Ferrule for 3/16" OD tubing	5/16-24 Flat-Bottom	500 psi (34 bar)	—	ETFE Blue	10-pk
P-133Nx	Flangeless Ferrule for 3/16" OD tubing	5/16-24 Flat-Bottom	500 psi (34 bar)	—	ETFE Natural	10-pk
P-140x	Super Flangeless Ferrule for 3/16" OD tubing	5/16-24 Flat-Bottom	500 psi (34 bar)	—	ETFE Green	10-pk
U-650x	Flangeless Ferrule for 1/4" OD tubing	1/2-20 Flat-Bottom	250 psi (17 bar)	—	ETFE Natural	10-pk
U-660x	Flangeless Ferrule for 5/16" OD tubing	1/2-20 Flat-Bottom	250 psi (17 bar)	—	ETFE Natural	10-pk



VHP Micro Fittings

Micro Fittings are specifically designed for use with microferrules. They are manufactured from a proprietary PEEK blend (PK) which allow them to be used at higher temperatures (up to 200° C) and higher pressures ideal for UHPLC applications.

VHP MicroFerrules and Fittings are made from a proprietary high performance PEEK polymer blend, a material which is unique in its ability to enable the use of capillary tubing in UHPLC environments. The new high pressure MicroFerrules are available for use with 1/32" or 360 µm OD tubing, and they are incorporated into several of our VHP products for capillary tubing.

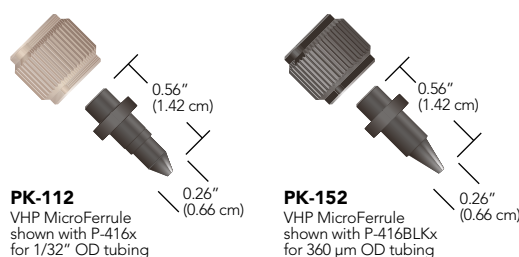

PK-112
VHP MicroFerrule
shown with P-416x
for 1/32" OD tubing

PK-152
VHP MicroFerrule
shown with P-416BLKx
for 360 µm OD tubing



APPLICATION NOTE

Caution: While the proprietary blend of the PK fittings will allow a fitting to attain a higher pressure and minimal cold flow properties relative to pure PEEK, some fittings molded of PK are known to be conductive. Use caution when employing PK fittings in high voltage applications.



NOTE

MicroTight fittings and MicroFerrules

While the MicroTight Female Nuts may be used with any of the separate MicroFerrules, the MicroFerrules themselves are port-specific and are thus not interchangeable. Additionally, the one-piece MicroTight fittings are also port-specific and should not be exchanged.

Part No.	Description	Port	Pressure Rating	Required Torque	Head Style	Material	Qty.
PK MICRO FERRULES AND FEMALE NUTS							
P-416	Female Nut for Microferrule	5/16-24 Coned	15,000 psi (1,035 bar)	4.0 in-lbs (0.45 N-m)	Female Knurl	PEEK, Natural	ea.
P-416BLK	Female Nut for Microferrule	5/16-24 Coned	15,000 psi (1,035 bar)	4.0 in-lbs (0.45 N-m)	Female Knurl	PEEK, Black	ea.
PK-112	VHP MicroFerrule for 1/32" OD Tubing	5/16-24 Coned	15,000 psi (1,035 bar)	—	—	PK	ea.
PK-152	VHP MicroFerrule for 360 µm OD Tubing	5/16-24 Coned	15,000 psi (1,035 bar)	—	—	PK	ea.



VHP PK Fittings

RELATED PRODUCTS

- Find unions, tees and crosses for VHP applications on page 75, and 74.

Ultra High Performance fittings are manufactured from a proprietary PEEK blend (PK) which allow them to be used at higher temperatures (up to 200 °C) and higher pressures.

The VHP PK One-Piece fittings are available for 10-32 coned, 6-32 coned, or M4 coned ports, and Two-Piece fittings are available to connect either 1/16" or 1/32" OD tubing into 10-32 coned ports in multiple styles.

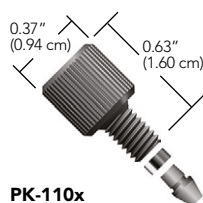

PK-110x
10-32 PK Fitting
shown with PK-100x for
1/16" OD tubing



PK-110x
10-32 PK Fitting
shown with PK-132x for
1/32" OD tubing

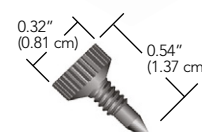

PK-126x
6-32 PK MicroTight® Fitting
for 1/32" OD tubing

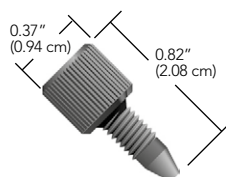

PK-120BLKx
10-32 PK Fitting
for 1/16" OD tubing

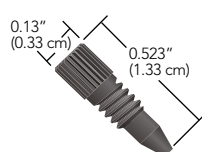

PK-126Hx
6-32 PK MicroTight® Fitting
for 1/32" OD tubing

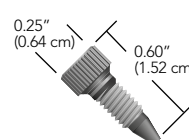

UH-904x
M4, 1/32" Fitting
for IDEX Health & Science
MX valves

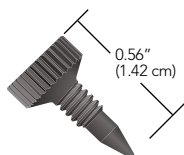

PK-124x
6-32 PK MicroTight® Fitting
for 1/32" OD tubing

Part No.	Description	Port	Pressure Rating	Required Torque	Head Style	Material	Qty.
PK VHP ONE-PIECE FITTINGS							
PK-120BLKx	PK One-Piece Fitting for 1/16" OD Tubing	10-32 Coned	12,000 psi (827 bar)	8.0 in-lbs (0.90 N-m)	Standard Knurl	PK	10-pk
PK-126Hx	PK One-Piece Headless Fitting for 1/32" OD Tubing	6-32 Coned	15,000 psi (1,035 bar)	3.0 in-lbs (0.34 N-m)	Headless Micro Knurl	PK	10-pk
PK-126x	PK One-Piece Fitting for 1/32" OD Tubing	6-32 Coned	15,000 psi (1,035 bar)	3.0 in-lbs (0.34 N-m)	Standard Micro Knurl	PK	10-pk
UH-904x	PK One-Piece Fitting for 1/32" OD Tubing	M4 Coned	15,000 psi (1,035 bar)	4.0 in-lbs (0.45 N-m)	Headless Knurl	PK	10-pk
PK VHP FITTINGS (LITETOUCH® STYLE, NUTS AND FERRULES SOLD SEPARATELY)							
PK-100x	PK Ferrule for 1/16" OD Tubing	10-32 Coned	16,500 psi (1,140 bar)	—	—	PK	10-pk
PK-110x	PK Nut for 1/16" OD Tubing	10-32 Coned	16,500 psi (1,140 bar)	8.0 in-lbs (0.90 N-m)	Standard Knurl	PK	10-pk
PK-132x	PK Ferrule for 1/32" OD Tubing	10-32 Coned	16,500 psi (1,140 bar)	—	—	PK	10-pk

Stainless Steel VHP Fittings

- › Pressure rated to 30,000 psi (2,070 bar)
- › Double compression ferrule design
- › Available with 10-32 threads for 1/16" OD tubing and M4 threads for 1/32" OD tubing

The all Stainless-Steel VHP Fittings include a unique ferrule system with two compression points to provide twice the grip of a standard ferrule. This design also allows the bite on the tubing to be less concentrated and does not restrict the inner diameter, as discussed in the Application Note. The ferrules for 1/16" OD tubing and 10-32 coned ports are two pieces, while the grooved ferrule for 1/32" OD tubing and M4 coned ports is a one-piece design for easier handling, but it will act as two pieces with double compression on the tubing as it is tightened down.



APPLICATION NOTE

In order to seal up to the stated pressure rating, the VHP-200-01 ferrule requires 20 in-lbs (2.25 N·m) of torque. Similar ferrules on the market require tightening torque of at least 30 in-lbs (3.3 N·m), which can result in a restricted tubing passage, as shown in the picture below. This restriction can increase turbulence and add a 'throttling' effect to the fluid pathway, resulting in mixing and other potential chromatographic problems.

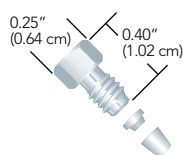

VHP-200x
VHP 10-32 Fitting
for 1/16" OD tubing

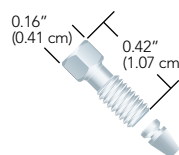

VHP-700x
VHP 6-40 Fitting
for 1/32" OD tubing

**IDEX Health & Science
VHP-200**

**Conventional Two
Piece Ferrule Design**

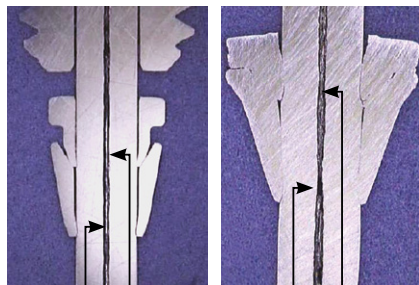

Uniform
Tubing Passage

Constricted
Tubing Passage

Part No.	Description	Port	Pressure Rating	Required Torque	Head Style	Material	Qty.
STAINLESS STEEL VHP FITTINGS (INCLUDES NUT AND FERRULE)							
VHP-200x	VHP Fitting for 1/16" OD	10-32 Coned	30,000 psi (2,070 bar)	20 in-lbs (2.25 N·m)	1/4" Hex	SST	10-pk
VHP-700x	VHP Fitting for 1/32" OD	6-40 Coned	30,000 psi (2,070 bar)	20 in-lbs (2.25 N·m)	4 mm Hex	SST	10-pk
STAINLESS STEEL VHP FERRULES							
VHP-200-01x	VHP Ferrule for 1/16" OD	10-32 Coned	30,000 psi (2,070 bar)	20 in-lbs (2.25 N·m)	—	SST	10-pk



Reusable VHP Fittings

- › Pressure rated up to 25,000 psi (1,720 bar)
- › Patented innovative design
- › Capable of up to ten repeat assembly cycles with no impact on pressure holding ability or carry-over
- › Available in 10-32 threads for 1/16" OD tubing and M4 threads for 1/32" OD tubing
- › Materials of construction: stainless steel and proprietary PEEK polymer blend (PK)
- › Quick component replacement, minimal downtime



RELATED PRODUCTS

- › Find tightening tools on page 50 designed to deliver the torque necessary for these fittings.

IDEX Health & Science introduces an innovative line of Very High Pressure (VHP) fittings, designed to withstand extreme pressures. This patented line of ground-breaking fitting systems is perfect for use within the increasingly demanding requirements of today's high performance analytical systems.

The Reusable VHP fittings can be reused when following the tightening torque specification listed below. With a polymer front ferrule, there is no damage to the tubing or receiving port, also increasing the life of these components.

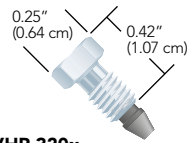

VHP-320x
10-32 VHP Fitting
for 1/16" OD tubing

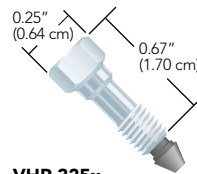

VHP-325x
10-32 VHP Fitting, Long
for 1/16" OD tubing

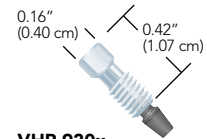

VHP-920x
M4 VHP Fitting
for 1/32" OD tubing

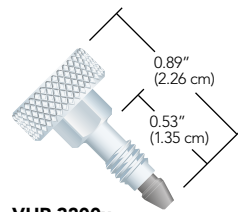

VHP-3200x
10-32 VHP Fitting
for 1/16" OD tubing

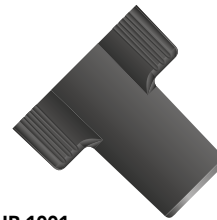

VHP-1001
VHP Fingertight
1/4" Hex Tool

Part No.	Description	Port	Pressure Rating	Required Torque	Head Style	Material	Qty.
REUSABLE VHP FITTINGS							
VHP-320x	VHP Fitting for 1/16" OD	10-32 Coned	25,000 psi (1,720 bar)	10 in-lbs (1.10 N-m)	1/4" Hex	SST/PK	10-pk
VHP-325x	VHP Fitting for 1/16" OD, Long	10-32 Coned	25,000 psi (1,720 bar)	10 in-lbs (1.10 N-m)	1/4" Hex	SST/PK	10-pk
VHP-920x	VHP Fitting for 1/32" OD	M4 Coned	25,000 psi (1,720 bar)	8 in-lbs (0.90 N-m)	4 mm Hex	SST/PK	10-pk
VHP-3200x	VHP Fitting for 1/16" OD	10-32 Coned	11,000 psi (760 bar)	3.5 in-lbs (0.40 N-m)	1/2" Knurl	SST/PK	10-pk
VHP-1001	VHP Fingertight 1/4" Hex Tool	—	—	—	—	PPS	ea.

Assorted Fittings Kits

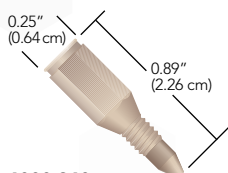

6000-360
M4 Fitting
M4 threads
for 1/32" OD tubing

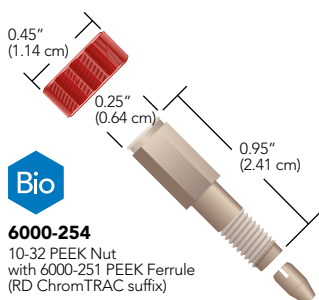

6000-254
10-32 PEEK Nut
with 6000-251 PEEK Ferrule
(RD ChromTRAC suffix)

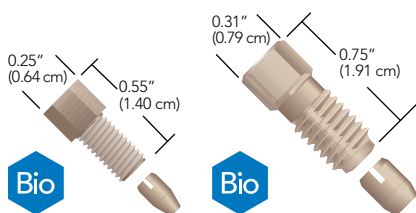

6000-255
10-32 PEEK Nut
with 6000-251 PEEK Ferrule

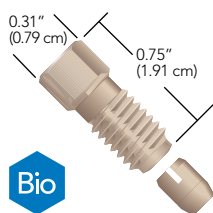

6000-078
5/16-24 PEEK Nut
with 6000-079 PEEK Ferrule

RELATED PRODUCTS

- › For PEEK tubing sleeves that can be used with these M4 RheFlex fittings, see page 52.
- › For reusable fittings that both work in UHPLC applications and can help ensure the tubing is fully inserted into the receiving port, see page 60.

RheFlex® M4 Fittings

- › Incorporates M4 coned threads for 1/32" OD tubing
- › Pressure rated to 5,000 psi (345 bar)

Our RheFlex M4 Fitting is designed to connect 1/32" OD tubing in MX Series II™ valves (see Actuated Valves, starting on page 119). This PEEK fitting has a one piece design, which eliminates the need for a separate nut and ferrule. The M4 Fitting design provides dependable zero dead volume connections for micro and nano applications. Due to the unique RheFlex gripping design, the M4 Fitting will hold to 5,000 psi (345 bar) on PEEK or with a PEEK tubing sleeve on fused silica tubing. A PEEK M4 Plug is also available.

Use ChromTRAC™ knobs with the RheFlex M4 Fitting for fingertight convenience and to color-code connections.

Two-Piece RheFlex Fingertight Fittings

The RheFlex Precision Two-Piece PEEK Fittings sets provide inert, biocompatible connections for instrumentation. These fittings have a reliable, time-tested design. Each 1/16" fittings set contains a 10-32 threaded nut and a specially-designed PEEK ferrule. Three lengths of the 1/16" nut are available: Standard, Short, and Extra Long. RheFlex Fingertight Fittings are rated for use up to 7,000 psi (483 bar). Also offered in this product line is the 6000-078 fitting, designed to connect 1/8" OD tubing into our manual preparative-scale injection valves. (See page 115 for more information on these valves.) *View the online product bulletin at: www.idex-hs.com.*

ChromTRAC™

- › Brightly colored knobs to easily track inlets and outlets of valves, columns, and detectors

All ChromTRAC-compatible RheFlex fittings offer the ChromTRAC knob option. Specify the ChromTRAC two letter suffix for the color choice when ordering. Please see the ChromTRAC Suffix Codes table below. For example, to order red ChromTRAC knobs with the RheFlex One-Piece Fitting on this page, specify 6000-282RD. No suffix indicates black knobs. *View the online product bulletin for RheFlex fittings at: www.idex-hs.com.*

ChromTRAC Suffix Codes

CODE	COLOR	CODE	COLOR
BL	Blue	WH	White
GN	Green	YL	Yellow
GY	Gray	MC	Multi-color (two each of blue, green, gray, red, and yellow)
RD	Red		

Add these letter suffixes to the end of the seven-digit part numbers of the 10-32 and M4 threaded RheFlex Fittings listed below.

Part No.	Description	Port	Pressure Rating	Head Style	Material	Qty.
RHEFLEX ONE-PIECE FITTINGS						
6000-360	RheFlex Fitting for 1/32" OD Tubing	M4 Coned	5,000 (345 bar)	1/4" Hex	PEEK, Natural	10-pk
RHEFLEX TWO-PIECE FITTINGS (INCLUDES FERRULES)						
6000-078	RheFlex Fitting for 1/8" OD Tubing	5/16-24 Coned	5,000 psi (345 bar)	5/16" Hex	PEEK, Natural	ea.
6000-254	RheFlex Fitting for 1/16" OD Tubing	10-32 Coned	7,000 psi (483 bar)	ChromTRAC knob	PEEK, Natural	10-pk
6000-255	RheFlex Fitting for 1/16" OD Tubing, Short	10-32 Coned	7,000 psi (483 bar)	1/4" Hex	PEEK, Natural	10-pk
REPLACEMENT FERRULES						
6000-079	RheFlex Ferrule for 1/8" OD Tubing	5/16-24 Coned	7,000 psi (483 bar)	ChromTRAC knob	PEEK, Natural	5-pk
6000-251	RheFlex Ferrule for 1/16" OD Tubing	10-32 Coned	7,000 psi (483 bar)	ChromTRAC knob	PEEK, Natural	10-pk

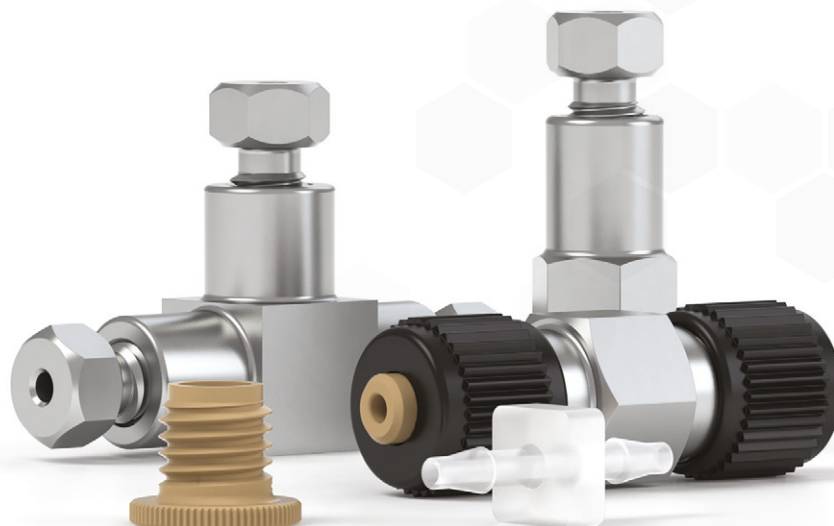

CONNECTORS

Connectors are designed to securely join tubing together or to facilitate the joining of tubing to other fluid pathway components. We offer multiport connectors with different thread and port configurations to meet your system requirements and connection needs. Some of our connectors feature a True ZDV (Zero Dead Volume) internal configuration that helps minimize the formation of dead volume in your fluidic pathway. Our versatile adapters help bring two connectors with different configurations together. Connectors are manufactured from 316 stainless steel or from inert polymers to ensure chemical compatibility with the fluid passing through. Peristaltic tube connectors are ideal for making connections with soft-walled, peristaltic tubing. Our extensive line of connectors includes tees, crosses, Luer Adapters, barbed and threaded adapters, and a variety of other options.

- | | | | |
|-----------|--|-----------|---|
| 63 | THREADED ADAPTERS | 79 | ACCESSORIES |
| 67 | HIGH PRESSURE
MULTIPORT
CONNECTORS | 80 | NANOPORT
ASSEMBLIES |
| 72 | ULTRA HIGH
PRESSURE MULTIPORT
CONNECTORS | 81 | LOW PRESSURE
MULTIPORT
CONNECTORS |
| 77 | MICROTIGHT®
ADAPTERS | 90 | LUER ADAPTERS |
| | | 91 | PERISTALTIC TUBE
CONNECTORS |



Threaded Adapters

- ▶ Threaded adapters in a variety of configurations
- ▶ English, Metric, and NPT threaded adapters offered
- ▶ Bring together connectors with different threads
- ▶ Manufactured from inert polymers — PEEK, PCTFE, ETFE, and PTFE

Two of the many challenges researchers face regularly, are trying to use one style of fitting for all connections, or trying to join two different sizes of tubing. To assist in overcoming these challenges we have engineered one of the most extensive threaded adapter lines available.

Threaded Adapters come in a wide variety of configurations to meet your system requirements. They are designed to effectively bring together connectors with different threads. We offer them in English, Metric, and NPT versions. Manufactured from inert polymers and stainless steel they deliver excellent chemical resistance.



English Threaded Adapters

Our versatile English Threaded Adapters are used specifically to securely attach connectors with different threads. We designed these adapters to work with English to English threaded geometries. Manufactured from Stainless Steel, PEEK, or Tefzel™ (ETFE), they deliver excellent solvent resistance.

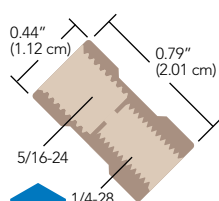

P-135
0.080" (2.05 mm) thru-hole

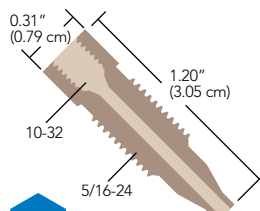

6000-076
0.066" (1.70 mm) thru-hole

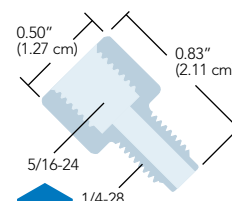

P-681
0.125" (3.20 mm) thru-hole

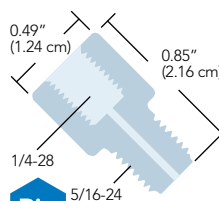

P-718
0.040" (1.00 mm) thru-hole

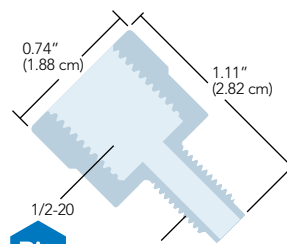

P-684
0.130" (3.30 mm) thru-hole

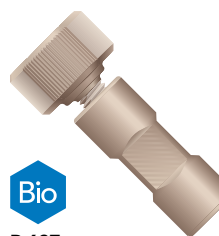

P-627
0.020" (0.50 mm) thru-hole
Includes (1) F-300 for 1/16" OD tubing

Threaded Adapters (Cont.)

NOTE

- When using an adapter with male (external) threads, we recommend you first attach the adapter body into the receiving port, and then connect your tubing and fitting into the head of the adapter body.

RELATED PRODUCTS

- Use the 6000-076 Adapter to connect 1/16" OD tubing to the Preparative-Scale Injector Valve (page 66).
- You may not need an adapter to connect 1/16" OD tubing into your flat-bottom port. A less expensive alternative is to use a Flangeless Nut and Ferrule starting on page 45 or a Super Flangeless™ Nut and Ferrule starting on page 39.

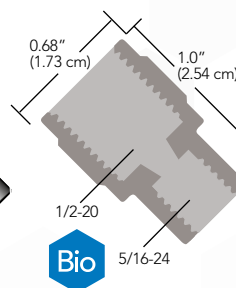
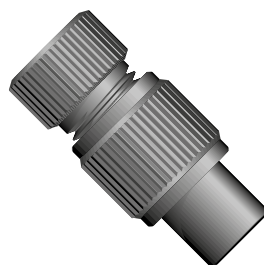

Bio

U-659

Tapered thru-hole
Includes (1) U-650/U-655
for 1/4" OD tubing

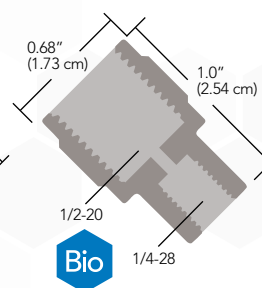

Bio

U-665

0.063" (1.60 mm) thru-hole
Includes (1) U-650/U-655
for 1/4" OD tubing



Bio

P-652

0.030" (0.75 mm) thru-hole
(Note the new knurled design)

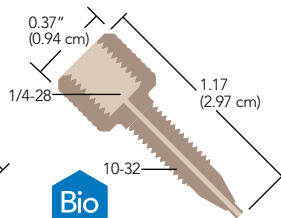
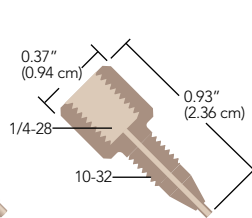

Bio

P-654

Extra Long, 0.030"
(0.76 mm) thru-hole

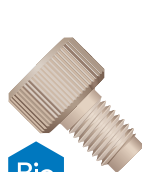

Bio

P-669-01

0.040" (1.00 mm) thru-hole

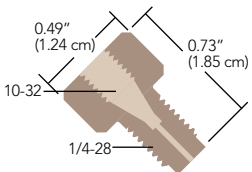

Bio

P-671

0.040" (1.00 mm) thru-hole

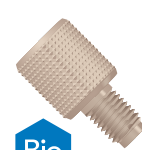
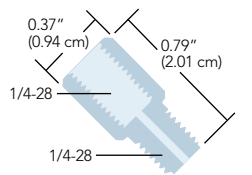

Bio

P-672

0.050" (1.25 mm) thru-hole

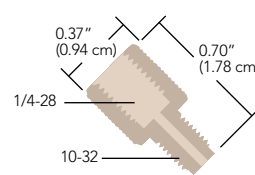

APPLICATION NOTE

Here are application ideas using two of our popular adapters:

- Many injection valves used in HPLC systems have 10-32 coned ports designed to accept 1/16" OD tubing. However, this may be a problem if large injection volumes are required (in excess of 10 mL). The most popular loops for large volume samples are made from 1/8" OD tubing, making it impossible to connect these larger volume loops to your injection valve. The solution: use our P-654 Adapter and the appropriate fittings for your sample loop. This set-up allows connection of 1/8" OD sample loop leads to your injection valve.
- Another potential application is connecting tubing to low-pressure solenoid valves with 1/4-28 flat-bottom ports. Most low-pressure valves of this type have very shallow threaded ports, which typically preclude the use of our Flangeless Fittings. However, by first threading our P-671 Adapter into the valve port(s), you can effectively use standard 1/4-28 fittings to connect your tubing into the backside of the adapter body. This also saves "wear and tear" on the threads in the valve ports.



Metric Threaded Adapters

Our versatile Metric Threaded Adapters are used specifically to effectively attach connectors with different threads. We designed these adapters to work with English to Metric threaded geometries. Manufactured from Stainless Steel, PEEK or Tefzel™ (ETFE) they deliver excellent solvent resistance.

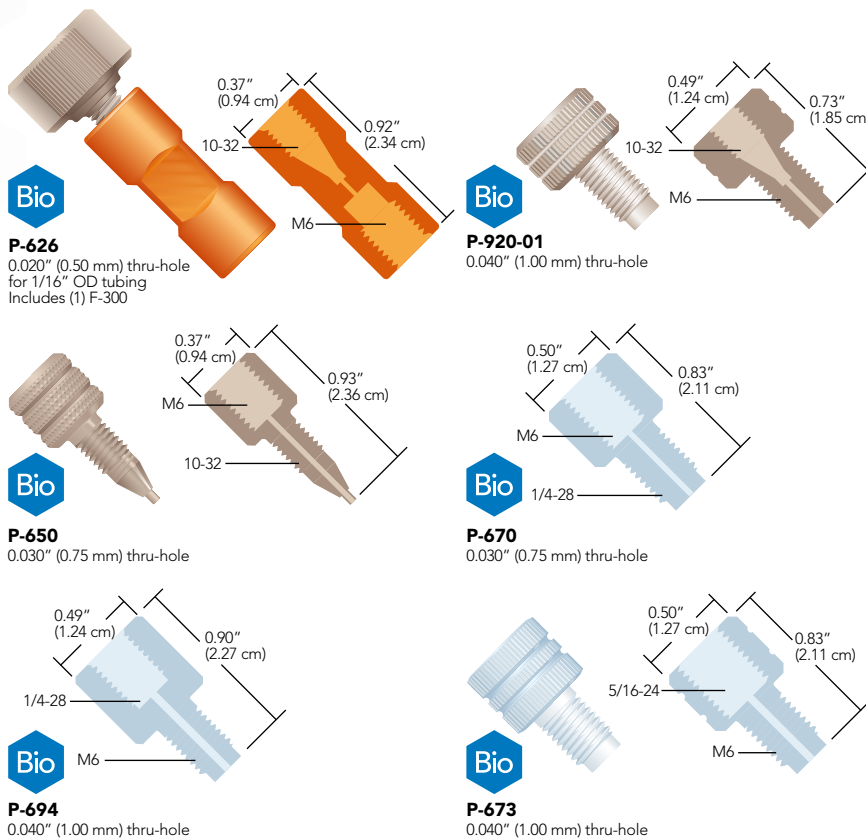

RELATED PRODUCTS

- › For an alternative to the Female M6 Adapters presented above, try a P-602 or P-622 Low Pressure Metric Union from page 84, along with the appropriate Metric Flangeless Fittings on page 43.
- › To direct connect your tubing into a flat-bottom port, find the appropriate Flangeless or Super Flangeless™ Fittings on page 45 and page 39 respectively.
- › Need metric fittings for your connections? See page 43.

Threaded Adapters (Cont.)



National Pipe Thread Adapters

These adapters make connections to female 1/8" and 1/4" National Pipe Thread (NPT) ports.

Manufactured from PEEK polymer, our NPT Adapters are durable and chemically resistant. We provide versions with either 1/4-28 or 5/16-24 flat-bottom threads, suitable for most low pressure applications.

Please Note: Wrap the threads on the NPT side of these adapters with thread seal tape (plumber's tape) to ensure a leak-free seal.

RELATED PRODUCTS

Replacement fittings for these adapters are located on the pages indicated below:

	Page(s)
1/4-28 for 1/8" OD tubing	41
5/16-24 for 1/8" OD tubing	41, 56
5/16-24 for 3/16" OD tubing	41

Other tubing/fitting combinations are available. For more information, please contact your local Distributor or IDEX Health & Science directly.

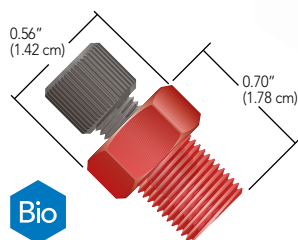

U-510
1/8" NPT to 1/4-28 Flat-Bottom Female Adapter for 1/8" OD tubing Includes (1) XP-308 Fitting

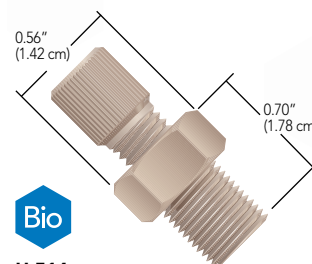

U-514
1/8" NPT to 5/16-24 Flat-Bottom Female Adapter for 3/16" OD tubing Includes (1) XP-132 Fitting

APPLICATION NOTE

Our U-500 and U-510 NPT Adapters are great for attaching 1/8" OD fluoropolymer sparging lines to sparging gas tank regulating valves. Simply thread the appropriately-sized NPT Adapter into the valve's receiving port and then attach your sparging tubing to the adapter body using the fittings provided.

Threaded Adapters

Part No.	Description	Includes	Thru-hole	Swept Volume	Pressure Rating	Qty.		
ENGLISH THREADED ADAPTERS								
6000-076	PEEK Adapter, 5/16-24 C, M to 10-32 C, F	N/A	0.066" (1.70 mm)	49.8 µL	3,000 psi (207 bar)	ea.		
P-135	PEEK Adapter, 5/16-24 FB, F to 1/4-28 F	N/A	0.080" (2.05 mm)	4.1 µL	1,000 psi (69 bar)	ea.		
P-627	PEEK Adapter, 10-32 C, F to 1/4-28 FB, F	(1) F-300	0.020" (0.50 mm)	0.30 µL	1,000 psi (69 bar)	ea.		
P-681	PCTFE Adapter, 5/16-24 FB, F to 1/4-28 FB, M	N/A	0.125" (3.20 mm)	96.6 µL	1,000 psi (69 bar)	ea.		
P-684	PCTFE Adapter, 1/2-20 FB, F to 1/4-28 FB, M	N/A	0.130" (3.30 mm)	121.7 µL	250 psi (17 bar)	ea.		
P-718	PCTFE Adapter, 5/16-24 FB, M to 1/4-28 FB, F	N/A	0.040" (1.00 mm)	10.3 µL	1,000 psi (69 bar)	ea.		
U-659	PEEK Adapter, 5/16-24 FB, F to 1/2-20 FB, F	(1) XU-655	Tapered**	42.0 µL	250 psi (17 bar)	ea.		
U-665	PEEK Adapter, 1/2-20 FB, F to 1/4-28 FB, F	(1) XU-655	0.063" (1.60 mm)	6.6 µL	250 psi (17 bar)	ea.		
P-652	PEEK Adapter, 1/4-28 FB, F to 10-32 C, M	N/A	0.030" (0.75 mm)	6.7 µL	1,000 psi (69 bar)	ea.		
P-654	PEEK Adapter, 1/4-28 FB, F to 10-32 C, M, Extra Long	N/A	0.030" (0.75 mm)	9.5 µL	1,000 psi (69 bar)	ea.		
P-669-01	PEEK Adapter, 10-32 C, F to 1/4-28 FB, M	N/A	0.040" (1.00 mm)	6.6 µL	1,000 psi (69 bar)	ea.		
P-671	PTFE Adapter, 1/4-28 FB, F to 1/4-28 FB, M	N/A	0.040" (1.00 mm)	8.0 µL	1,000 psi (69 bar)	ea.		
P-672	PEEK Adapter, 1/4-28 FB, F to 10-32 FB, M	N/A	0.050" (1.25 mm)	11.4 µL	1,000 psi (69 bar)	ea.		
METRIC M6 THREADED ADAPTERS								
P-626	PEEK Adapter, 10-32 C, F to M6 FB, F	(1) F-300	0.020" (0.50 mm)	0.3 µL	1,000 psi (69 bar)	ea.		
P-650	PEEK Adapter, M6 FB, F to 10-32 C, M Standard	N/A	0.030" (0.75 mm)	6.7 µL	1,000 psi (69 bar)	ea.		
P-670	PCTFE Adapter, M6 FB, F to 1/4-28 FB, M	N/A	0.030" (0.75 mm)	2.6 µL	1,000 psi (69 bar)	ea.		
P-673	PCTFE Adapter, 5/16-24 FB, F to M6 FB, M	N/A	0.040" (1.00 mm)	9.9 µL	1,000 psi (69 bar)	ea.		
P-694	PCTFE Adapter, 1/4-28 FB, F to M6 FB, M	N/A	0.040" (1.00 mm)	11.3 µL	1,000 psi (69 bar)	ea.		
P-920-01	PEEK Adapter, 10-32 C, F to M6 FB, M	N/A	0.040" (1.00 mm)	8.0 µL	1,000 psi (69 bar)	ea.		
1/8" MALE NATIONAL PIPE THREAD ADAPTERS								
Part No.	Description	Color	Tubing OD	Includes	Thru-hole	Swept Volume	Pressure Rating	Qty.
U-510	PEEK 1/8" NPT, M to 1/4-28 FB, F Adapter	Red	1/8"	(1) XP-308	0.062" (1.60 mm)	17.3 µL	500 psi (34 bar)	ea.
U-514	PEEK 1/8" NPT, M to 5/16-24 FB, F Adapter	Natural	3/16"	(1) XP-132	0.125" (3.2 mm)	70.4 µL	500 psi (34 bar)	ea.
1/4" MALE NATIONAL PIPE THREAD ADAPTERS								
U-500	PEEK 1/4" NPT, M to 1/4-28 FB, F Adapter	Red	1/8"	(1) XP-308	0.062" (1.60 mm)	17.3 µL	500 psi (34 bar)	ea.
U-504	PEEK 1/4" NPT, M to 5/16-24 FB, F Adapter	Natural	3/16"	(1) XP-132	0.125" (3.2 mm)	70.4 µL	500 psi (34 bar)	ea.

F = Female (internal) threads; M = Male (external) threads; XL = extra long; C = Coned; FB = Flat-Bottom

* The pressure rating of this adapter exceeds the pressure holding ability of the fittings and tubing used with it.

** Thru-hole tapers from 0.188" (4.80 mm) to 0.125" (3.20 mm).



High Pressure Mixing Tees

Mixing Tees utilize a specifically engineered internal geometry to efficiently mix two fluid streams into one combined stream. Mixing Tees are ideal for microbore or analytical gradient HPLC. These mixing tees are specifically designed for high pressure applications.

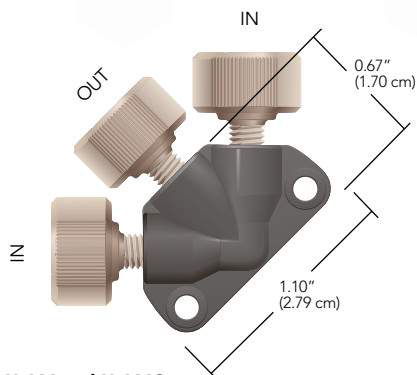

U-466 and U-466S
Static Mixing Tees with F-300 Fingertight Fittings for 1/16" OD tubing

Static Mixing Tees

- › PEEK body with two-piece fingertight fittings
- › Low swept volume

Static Mixing Tees are ideal for microbore or analytical gradient HPLC. They have a low swept volume of 2.2 μL (includes frit volume) and are designed for flow rates of 0.5 to 3 mL/min and a maximum pressure of 5,000 psi (345 bar). The back pressure caused by the tee is typically only 10 to 20 psi (0.7 to 1.4 bar) at these flow rates. The thru-holes are 0.020" (0.50 mm) and the center port features a 10 μm UHMWPE or stainless steel frit that aids mixing.

NOTE

- › Turbulent mixing of solvents often increases outgassing. To maintain a bubble-free fluid pathway, we recommend solvent degassing when using this product.
- › The frit incorporated into our U-466 and U-466S Static Mixing Tees is not replaceable. If it becomes clogged, the Mixing Tee must be replaced.

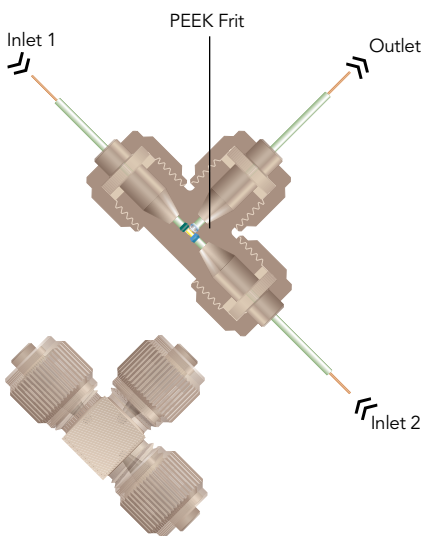

M-540
Micro Static Mixing Tee 0.010" thru-hole with fittings included (tubing and tubing sleeves not included)

Micro Static Mixing Tee

- › Constructed of inert PEEK and PCTFE
- › Low swept volume of 0.95 μL
- › Designed for flow rates of 20–250 $\mu\text{L}/\text{min}$

Our Micro Static Mixing Tee utilizes a specifically engineered internal geometry to efficiently mix two fluid streams into one combined stream. The center port also features a 0.5 μm porosity PEEK polymer frit to aid in mixing. This frit adds a maximum of 20 psi (1.4 bar) back pressure to most systems (within the stated flow rate range). The Mixing Tee handles a maximum pressure of 5,000 psi (345 bar) when directly connecting 1/16" OD tubing, or up to 4,000 psi (276 bar) with capillary tubing when using our NanoTight™ Fittings and Tubing Sleeves (page 37).

RELATED PRODUCTS

- › See our Vacuum Degassing Systems on page 154.
- › Our standard Static Mixing Tees are designed for flow rates from 0.5 mL/min to 3 mL/min.

High Pressure Mixing Tees (Cont.)



APPLICATION NOTE

Several researchers use our PEEK MicroTee to introduce ionizing voltage to their fluid stream just prior to a Mass Spectrometer¹. MicroTees are well suited for this application due to advantageous internal geometry and PEEK polymer's electrical resistance. The materials required for this setup are as follows: one gold or platinum conducting wire, one P-775 or P-875 MicroTee (this page), one MicroTight Tubing Sleeve (page 52) for the conducting wire (as needed to accommodate wire diameter), and at least two more MicroTight Tubing Sleeves (page 52) to connect your capillary tubing.

To set up a similar connection, first thread your wire through the appropriate tubing sleeve, if necessary, with the wire extending beyond both ends of the sleeve. Slip the female nut included with the MicroTee over the wire or sleeved wire, followed by the ferrule — ensuring the wire (and its sleeve) extends well past the end of the ferrule tip. Align the tip of the wire with the thru-hole of the MicroTee and gently insert the wire until it bottoms out. Now finger tighten the female nut into place. Attach your flow path tubing to the MicroTee's two other available ports, following the instructions provided with the MicroTee.

Begin fluid flow through the tee and apply voltage to the conducting wire lead. This setup typically provides effective electrospray ionization in applications having a flow rate of 100 $\mu\text{L}/\text{min}$ or greater.

¹ One such paper describing pioneering electrospray work: *Protein Identification at the Low Femtomole Level from Silver-Stained Gels Using a New Fritless Electrospray Interface for Liquid Chromatography-Microspray and Nanospray Mass Spectrometry*. Christine L. Gatlin, Gerd R. Kleemann, Lara G. Hays, Andrew J. Link, John R. Yates III (1998) *Analytical Biochemistry* 263, 93-101.

MicroTee & Cross for Capillary Tubing

- › Direct connect 1/16", 1/32", 360 μm OD tubing, plus other capillary tubing
- › Low swept volume

Use our MicroTees and MicroCrosses to join capillary tubing. All of these products are made entirely of PEEK and have 0.006" (0.150 mm) thru-holes, with resulting swept volumes ranging from 29 to 81 nL.



NOTE

- › Use only the ferrules supplied with each connector — they are not interchangeable. Replacement ferrules and female nuts are available on page 35. For MicroUnions, MicroTees, and MicroCrosses for UHPLC applications, see page 72.

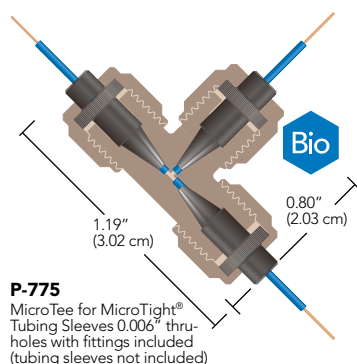

P-775
MicroTee for MicroTight[®] Tubing Sleeves 0.006" thru-holes with fittings included (tubing sleeves not included)

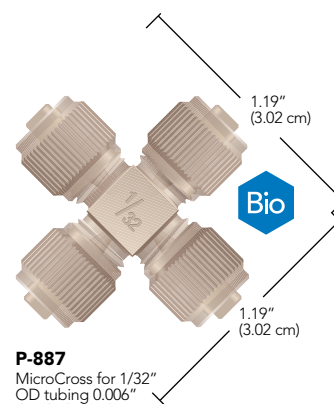

P-887
MicroCross for 1/32" OD tubing 0.006" thru-holes with fittings included

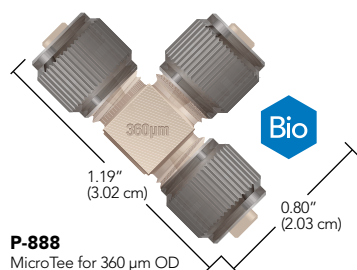

P-888
MicroTee for 360 μm OD tubing 0.006" thru-holes with fittings included

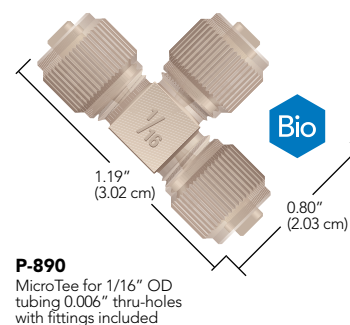

P-890
MicroTee for 1/16" OD tubing 0.006" thru-holes with fittings included

High Pressure Mixing Tees

Part No.	Description	Threads	Includes	Thru-hole	Swept Volume	Pressure Rating	Qty.
STATIC MIXING TEE							
U-466	PEEK Static Mixing Tee for 1/16" OD Tubing, 10 μm UHMWPE Frit	10-32 Coned	(3) F-300	0.020" (0.50 mm)	2.2 μL	5,000 psi (345 bar)	ea.
U-466S	PEEK Static Mixing Tee for 1/16" OD Tubing, 10 μm SST Frit	10-32 Coned	(3) F-300	0.020" (0.50 mm)	2.2 μL	5,000 psi (345 bar)	ea.
MICRO STATIC MIXING TEE							
M-540	PEEK Micro Static Mixing Tee, for 1/16" OD Tubing	5/16-24 Coned	(3) F-132/P-416	0.010" (0.250 mm)	0.95 μL	5,000 psi (345 bar)	ea.
MICROTEE, MICROCROSS AND MICROELBOW							
P-775	PEEK MicroTee for MicroTight Sleeves	5/16-24 Coned	(3) F-172, (3) P-416	0.006" (0.150 mm)	29 nL	4,000 psi (276 bar)	ea.
P-777	PEEK MicroCross for MicroTight Sleeves	5/16-24 Coned	(4) F-172, (4) P-416	0.006" (0.150 mm)	38 nL	4,000 psi (276 bar)	ea.
P-875	PEEK MicroTee with Mounting Hole, for MicroTight Sleeves	5/16-24 Coned	(3) F-172, (3) P-416	0.006" (0.150 mm)	29 nL	4,000 psi (276 bar)	ea.
P-885	PEEK MicroTee for 1/32" OD Tubing	5/16-24 Coned	(3) F-112, (3) P-416	0.006" (0.150 mm)	29 nL	5,000 psi (345 bar)	ea.
P-887	PEEK MicroCross for 1/32" OD Tubing	5/16-24 Coned	(4) F-112, (4) P-416	0.006" (0.150 mm)	38 nL	5,000 psi (345 bar)	ea.
P-888	PEEK MicroTee for 360 μm OD Tubing	5/16-24 Coned	(3) F-152, (3) P-416BLK	0.006" (0.150 mm)	29 nL	5,000 psi (345 bar)	ea.
P-889	PEEK MicroCross for 360 μm OD Tubing	5/16-24 Coned	(4) F-152, (4) P-416BLK	0.006" (0.150 mm)	38 nL	5,000 psi (345 bar)	ea.
P-890	PEEK MicroTee for 1/16" OD Tubing	5/16-24 Coned	(3) F-132, (3) P-416	0.006" (0.150 mm)	58 nL	5,000 psi (345 bar)	ea.
P-891	PEEK MicroCross for 1/16" OD Tubing	5/16-24 Coned	(4) F-132, (4) P-416	0.006" (0.150 mm)	81 nL	5,000 psi (345 bar)	ea.



High Pressure Unions

PEEK ZDV Unions

Our PEEK zero-dead-volume (ZDV) Unions come complete with two F-300 Fingertight Fittings for 1/16" OD tubing and are pressure rated to 5,000 psi (344 bar).

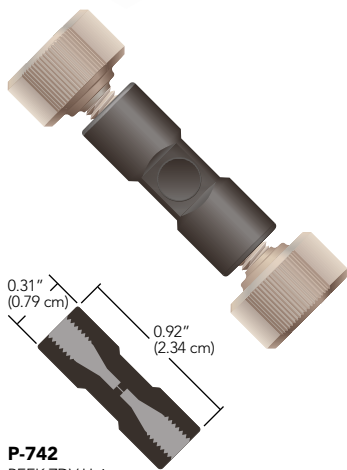

P-742
PEEK ZDV Union
0.010" thru-hole with
F-300 Fittings

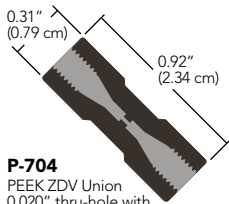

P-704
PEEK ZDV Union
0.020" thru-hole with
F-300 Fittings

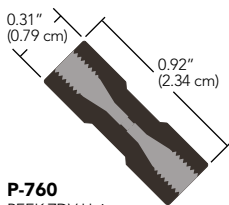

P-760
PEEK ZDV Union
0.050" thru-hole with
F-300 Fittings

Bio-Inert UHPLC Unions

- › Unique, Patent-Pending Process allows a fully-PEEK fluid contact area combined with the strength of stainless steel
- › Pressure rated to 17,400 psi (1,200 bar)
- › Two inner diameters available: 0.008" and 0.016"

These unions are specifically engineered for Bio-Inert UHPLC applications. Combining the physical strength of 316 stainless steel with the inertness and biocompatibility of an all-PEEK fluid pathway, these unions will work well in applications where pressures reach up to 17,400 psi (1,200 bar) — without allowing metal contact by the fluid.

Neither union comes with fittings, but can be paired successfully with any 10-32 coned fitting that uses a polymer nose or ferrule.

Note: All-stainless steel fittings should NOT be used with these unions, as they will damage the internal conical seat.

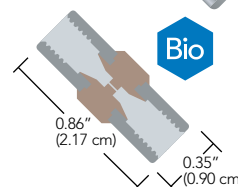
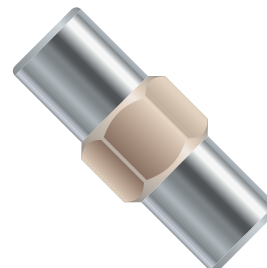

UP-700
Bio-Inert UHPLC Union 0.008" thru-hole for 1/16" OD tubing

NanoTight™ Union

NanoTight Unions improve capillary tubing connections in several ways. The internal design of the union greatly reduces the incidence of tubing misalignment. When using 1/16" OD tubing sleeves (found on page 52) to connect capillary tubing, the webbed thru-hole minimizes breaking of fused silica while adding only miniscule swept volume. The results are fewer blockages, fewer flow rate reductions and fewer back pressure problems.

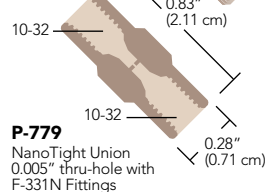
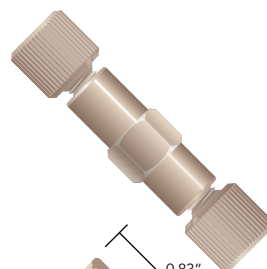

P-779
NanoTight Union
0.005" thru-hole with
F-331N Fittings

Part No.	Description	Threads	Includes	Thru-hole	Swept Volume	Pressure Rating	Qty.
BIO-INERT UHPLC UNIONS							
UP-700	Bio-Inert UHPLC Union for 1/16" OD Tubing, Natural (Tan)	10-32 Coned	N/A	0.008" (0.20 mm)	0.05 µL	17,400 psi (1,200 bar)	ea.
PEEK ZDV UNIONS							
P-704	PEEK Union for 1/16" OD Tubing	10-32 Coned	(2) F-300	0.020" (0.50 mm)	0.28 µL	5,000 psi (344 bar)	ea.
P-742	PEEK Union for 1/16" OD Tubing	10-32 Coned	(2) F-300	0.010" (0.25 mm)	0.07 µL	5,000 psi (344 bar)	ea.
P-760	PEEK Union for 1/16" OD Tubing	10-32 Coned	(2) F-300	0.050" (1.25 mm)	1.2 µL	5,000 psi (344 bar)	ea.
NANOTIGHT UNION							
P-779	PEEK NanoTight Union for 1/16" OD Tubing and Tubing Sleeves	10-32 Coned	(2) F-331N	0.005" (125 µm)	8 nL	5,000 psi (344 bar)	ea.

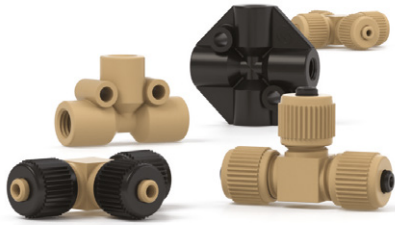

High Pressure PEEK Tees & Crosses

- › Highest pressure holding flat-bottom fitting system we offer
- › Eliminates loosening of fittings due to tubing twist
- › Excellent for Tubing Assemblies
- › Holds tight even through vibration

Our PEEK Tees and Crosses include high pressure F-300 PEEK Fingertight Fittings — allowing maximum operating pressures to 3,500 psi (241 bar) when used with 1/16" OD PEEK or stainless steel tubing.

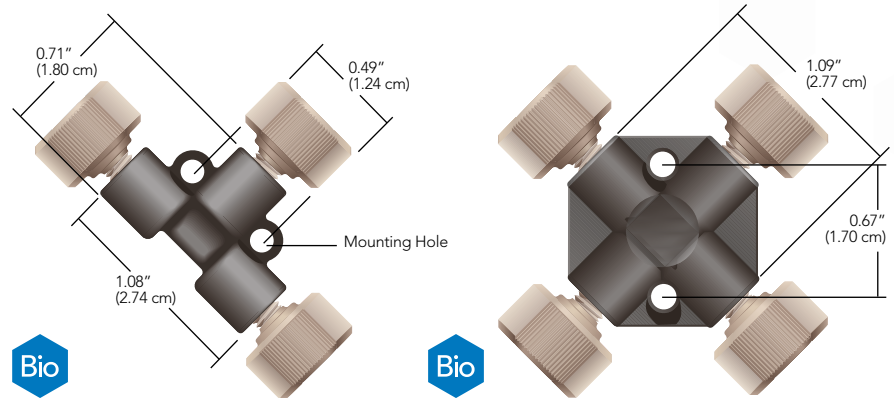

P-727 PEEK Tee
0.020" thru-hole with F-300 Fittings

P-729 PEEK Cross
0.020" thru-hole with F-300 Fittings

PEEK 7-Port Manifold

Combine several streams into one or split one fluid stream into several. This PEEK 7-Port Manifold comes complete with F-331 Fingertight Fittings for 1/16" OD tubing and offers a pressure rating of 5,000 psi (345 bar). Seal unused ports with any of our polymer 10-32 coned plugs on page 55.

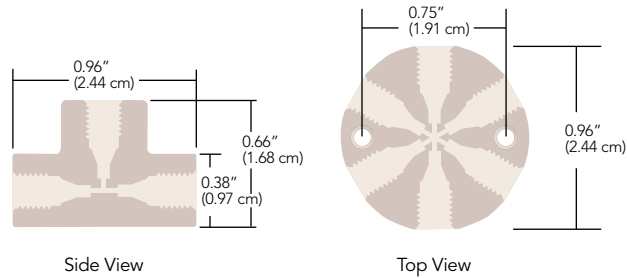

P-170
PEEK 7-Port Manifold 0.020" thru-holes with F-331 Fittings

Part No.	Description	Threads	Includes	Thru-hole	Swept Volume	Pressure Rating	Qty.
PEEK TEES AND CROSSES							
P-727	PEEK Tee for 1/16" OD Tubing	10-32 Coned	(3) F-300	0.020" (0.50 mm)	0.57 μ L	3,500 psi (241 bar)	ea.
P-728	PEEK Tee for 1/16" OD Tubing	10-32 Coned	(3) F-300	0.050" (1.25 mm)	3.0 μ L	3,500 psi (241 bar)	ea.
P-729	PEEK Cross for 1/16" OD Tubing	10-32 Coned	(4) F-300	0.020" (0.50 mm)	0.72 μ L	3,500 psi (241 bar)	ea.
PEEK MANIFOLD							
P-170	PEEK 7-Port Manifold for 1/16" OD Tubing	10-32 Coned	(7) F-331	0.020" (0.50 mm)	2.2 μ L	5,000 psi (345 bar)	ea.

High Pressure MicroTight® Unions

Conductive MicroTight Union

The Conductive MicroTight Union manufactured by IDEX Health & Science provides an excellent opportunity to introduce voltage into an electrospray or capillary electrophoresis system. With an extremely low internal volume of 16 nL, this union can be placed inline with 360 µm OD capillary tubing. Mount and apply voltage to these unions using our Insulating Mounting Bracket below.

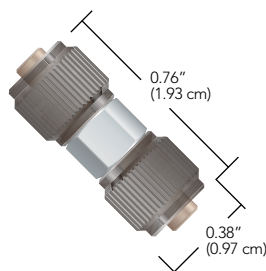

M-572

Conductive MicroTight Union for 360 µm OD tubing with fittings and Capsule Union included

APPLICATION NOTE

For an example of using a Conductive MicroTight Union in a pressure driven ion preconcentration application see: "Self-Sealed Vertical Polymeric Nanoporous Junctions for High Throughput Nanofluidic Applications."

Sun Jae Kim and Jong Yoon Han. *Analytical Chem.* 2008, 80: 3507-3511.

RELATED PRODUCTS

- » Easily integrate the Conductive MicroTight Union into your system with our Insulating Mounting Bracket, shown on page 79.

MicroTight® Connectors for Capillary Tubing

Connect two pieces of capillary tubing with our PEEK MicroTight Connectors. The True ZDV Unions allow two pieces of tubing to connect directly to each other — using the included gauge plug to ensure proper alignment. The standard union and elbow both feature a 0.006" (0.150 mm) thru-hole, adding only a small amount of additional flow-path volume to help ensure proper chromatographic results.

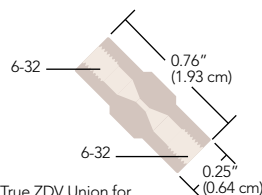

P-720

MicroTight True ZDV Union for use with MicroTight Sleeves with fittings and gauge plug included

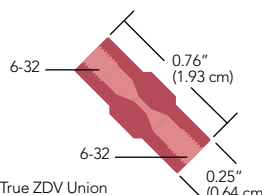

P-771

MicroTight True ZDV Union for 1/32" OD tubing with fittings and gauge plug included

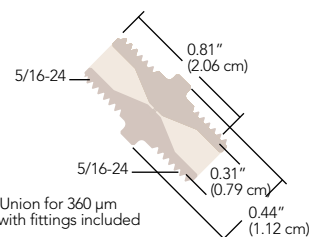

P-772

MicroTight Union for 360 µm OD tubing with fittings included

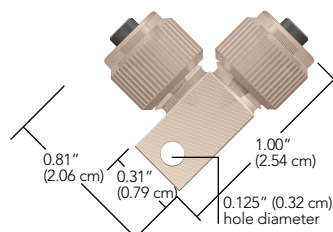

P-874

MicroElbow for MicroTight Tubing Sleeves with fittings included

Part No.	Description	Threads	Includes	Thru-hole	Swept Volume	Pressure Rating	Qty.
MICROTIGHT UNIONS							
P-720	PEEK True ZDV Union for MicroTight Sleeves	6-32 Coned	(2) F-125, (1) P-553	N/A	N/A	4,000 psi (276 bar)	ea.
P-771	PEEK True ZDV Union for 1/32" OD Tubing	6-32 Coned	(2) F-126S, (1) P-553	N/A	N/A	5,000 psi (345 bar)	ea.
P-772	PEEK Union for 360 µm OD Tubing	5/16-24 Coned	(2) F-152, (2) P-416BLK	0.006" (0.150 mm)	5 nL	5,000 psi (345 bar)	ea.
P-874	PEEK MicroElbow for MicroTight Sleeves	5/16-24 Coned	(2) F-172, (2) P-416	0.006" (0.150 mm)	20 nL	4,000 psi (276 bar)	ea.
REPLACEMENT GAUGE PLUGS (TO ACHIEVE TRUE ZDV CONNECTIONS WITH OUR P-720 AND P-771 UNIONS)							
P-553	Gauge Plug, Delrin®	6-32 Coned	N/A	N/A	N/A	N/A	ea.
CONDUCTIVE MICROTIGHT UNIONS							
M-572	Conductive Union for 360 µm OD Tubing, PEEK/SST	5/16-24 Coned	(2) F-152, (2) P-416BLK, (1) M-128NF	0.011" (0.279 mm)	16 nL	5,000 psi (345 bar)	ea.



High Pressure Stainless Steel Tees & Crosses

These 316 stainless steel connectors come complete with 10-32 stainless steel fittings for use with 1/16" OD tubing and are rated to 20,000 psi (1,380 bar). They are compatible with any 10-32 coned threaded fittings.

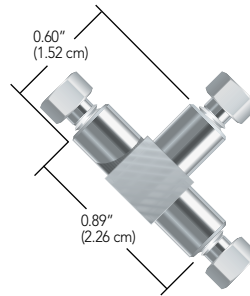

U-428 Stainless Steel Tee
0.020" thru-hole with U-400 and U-401 Fittings

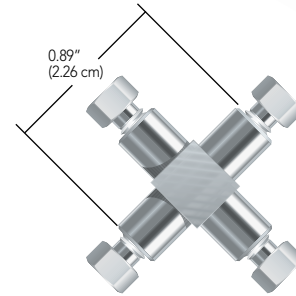

U-430 Stainless Steel Cross
0.020" thru-hole with U-400 and U-401 Fittings

Part No.	Description	Threads	Includes	Thru-hole	Swept Volume	Pressure Rating	Qty.
VHP TEE FOR 1/16" OD TUBING							
U-428	Stainless Steel Tee for 1/16" OD Tubing	10-32 Coned	(3) U-400, (3) U-401	0.020" (0.50 mm)	0.57 µL	20,000 psi (1,380 bar)	ea.
U-429	Stainless Steel Tee for 1/16" OD Tubing	10-32 Coned	(3) U-400, (3) U-401	0.040" (1.00 mm)	2.1 µL	20,000 psi (1,380 bar)	ea.
U-430	Stainless Steel Cross for 1/16" OD Tubing	10-32 Coned	(4) U-400, (4) U-401	0.020" (0.50 mm)	0.72 µL	20,000 psi (1,380 bar)	ea.
U-431	Stainless Steel Cross for 1/16" OD tubing	10-32 Coned	(4) U-400, (4) U-401	0.040" (1.00 mm)	2.5 µL	20,000 psi (1,380 bar)	ea.

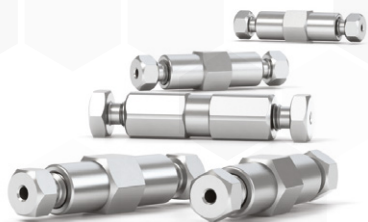

VHP Stainless Steel ZDV Unions

- › Supplied with fittings for 1/16" OD or 1/8" OD tubing
- › Manufactured from 316 stainless steel
- › All union assemblies rated to 20,000 psi (1,380 bar) or higher

NOTE

It is possible to order the products on this page without the fittings. Simply use a -01 at the end of the product number to order the union body without fittings.

Our high pressure, zero-dead-volume (ZDV) unions are precision machined from 316 stainless steel, carefully passivated, then thoroughly rinsed. Each comes complete with stainless steel nuts and ferrules.

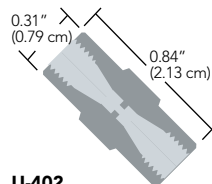
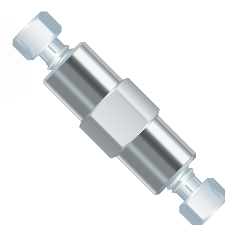

U-402
ZDV Union
0.020" thru-hole
for 1/16" OD tubing

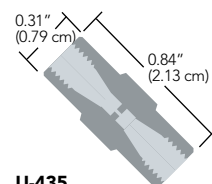

U-435
ZDV Union
0.010" thru-hole
for 1/16" OD tubing

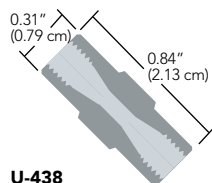

U-438
True ZDV Union
0.067" thru-hole
for 1/16" OD tubing

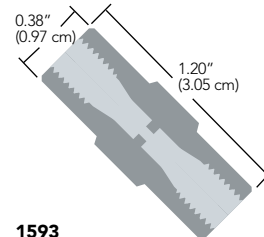

1593
ZDV Union
0.050" thru-hole
for 1/8" OD tubing



U-411
NanoTight™ Union
0.007" thru-hole
for 1/16" OD tubing

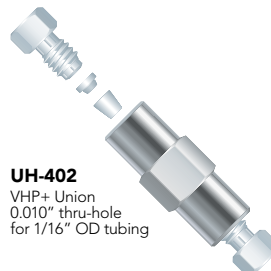

UH-402
VHP+ Union
0.010" thru-hole
for 1/16" OD tubing



U-322
VICI® (Valco) Compatible
ZDV Union 0.020" thru-hole
for 1/16" OD tubing



U-412
Waters Compatible
ZDV Union 0.020" thru-hole
for 1/16" OD tubing

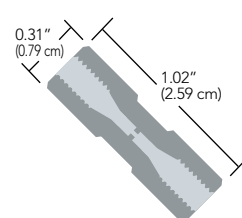

Part No.	Description	Threads	Includes	Thru-hole	Swept Volume	Pressure Rating	Qty.
VHP STAINLESS STEEL ZDV UNIONS							
1593	Stainless Steel Union for 1/8" OD Tubing	1/4-28 Coned	(2) C-235/C-236	0.050" (1.25 mm)	1.48 µL	20,000 psi (1,380 bar)	ea.
U-402	Stainless Steel Union for 1/16" OD Tubing	10-32 Coned	(2) U-400/U-401	0.020" (0.50 mm)	0.13 µL	20,000 psi (1,380 bar)	ea.
U-411	Stainless Steel Union for 1/16" OD Tubing	10-32 Coned	(2) U-400/U-401	0.007" (178 µm)	13 nL	20,000 psi (1,380 bar)	ea.
U-435	Stainless Steel Union for 1/16" OD Tubing	10-32 Coned	(2) U-400/U-401	0.010" (0.25 mm)	20 nL	20,000 psi (1,380 bar)	ea.
U-438	Stainless Steel Union for 1/16" OD Tubing	10-32 Coned	(2) U-400/U-401, (1) P-554 Gauge Plug	0.067" (1.70 mm)	Near 0 µL	20,000 psi (1,380 bar)	ea.
UH-402	VHP+ Stainless Steel Union for 1/16" OD Tubing	10-32 Coned	(2) VHP-200	0.010" (0.25 mm)	20 nL	30,000 psi (2,070 bar)	ea.
VICI (VALCO) COMPATIBLE ZDV UNION							
U-322	Stainless Steel Union for 1/16" OD Tubing	10-32 Coned	(2) U-320/U-321	0.020" (0.50 mm)	0.15 µL	20,000 psi (1,380 bar)	ea.
WATERS® COMPATIBLE ZDV UNION							
U-412	Stainless Steel Union for 1/16" OD Tubing	10-32 Coned	(2) U-410/U-401	0.020" (0.50 mm)	0.10 µL	20,000 psi (1,380 bar)	ea.

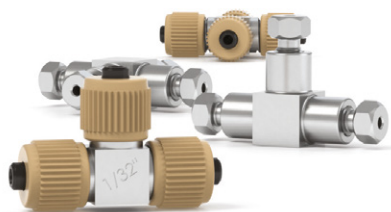

VHP Tees & Crosses

Our VHP Stainless Steel Tees and Crosses are precision machined from durable stainless steel. It is mechanically designed for bringing together three or four pieces of tubing. Our VHP Tees & Crosses have an extremely high pressure rating of 30,000 psi (2070 bar).

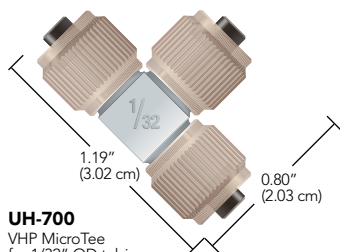

UH-700
VHP MicroTee
for 1/32" OD tubing
with fittings included

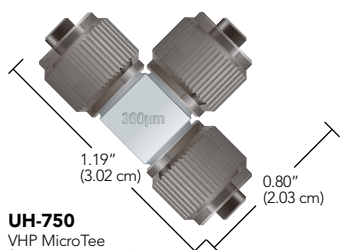

UH-750
VHP MicroTee
for 360 μm OD tubing
with fittings included

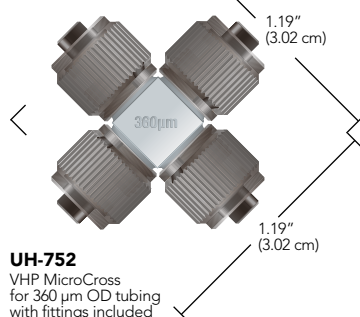

UH-752
VHP MicroCross
for 360 μm OD tubing
with fittings included

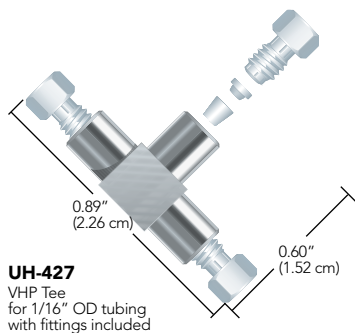

UH-427
VHP Tee
for 1/16" OD tubing
with fittings included

VHP Tees & Crosses for Capillary Tubing

- › Direct-connect either 360 μm or 1/32" OD tubing — no sleeves required!
- › Available in both tee and cross configurations
- › Pressure rated to 15,000 psi (1,034 bar)

To help facilitate multi-port connections in UHPLC applications, our experts have developed a line of MicroTees and MicroCrosses, manufactured from stainless steel and featuring small thru-holes and very low internal volume. Additionally, the stainless steel construction allows these products to be used in applications where electrical conductivity is desired.

Included with the MicroTees and MicroCrosses are the VHP MicroFerrules found on page 59. The P-278 Extender Tool on page 33 can be used to tighten the female nuts that are included with these connectors.



APPLICATION NOTE

Why 1/32" OD Tubing and 360 μm OD Tubing?

IDEX Health & Science has focused strongly on the development of a variety of connectors and accessories for 1/32" OD tubing and 360 μm OD tubing. We have focused on these specific sizes due to their overwhelming popularity in analytical instruments, especially where micro and nano-scale analyses are being performed. By creating products designed for these popular sizes, the overall connection is easier to make and generally holds to increased pressures over connections where tubing sleeves are involved.

VHP Tee for 1/16" OD Tubing

IDEX Health & Science offers this Very High Pressure (VHP) Tee Connector, designed to bring three pieces of tubing together. The all-316 stainless steel connector is designed for 1/16" OD tubing and is pressure rated to 30,000 psi (2,070 bar).

Part No.	Description	Threads	Includes	Thru-hole	Swept Volume	Pressure Rating	Qty.
VHP TEE FOR 1/16" OD TUBING							
UH-427	VHP Tee for 1/16" OD Tubing, SST	10-32 Coned	(3) VHP-200	0.020" (0.50 mm)	0.57 μL	30,000 psi (2,070 bar)	ea.
VHP TEES & CROSSES FOR CAPILLARY TUBING							
UH-700	VHP MicroTee for 1/32" OD Tubing, PEEK/SST	5/16-24 Coned	(3) PK-112, (3) P-416	0.010" (0.25 mm)	84 nL	15,000 psi (1,034 bar)	ea.
UH-750	VHP MicroTee for 360 μm OD Tubing, PEEK/SST	5/16-24 Coned	(3) PK-152, (3) P-416BLK	0.010" (0.25 mm)	84 nL	15,000 psi (1,034 bar)	ea.
UH-752	VHP MicroCross for 360 μm OD Tubing, PEEK/SST	5/16-24 Coned	(4) PK-152, (4) P-416BLK	0.010" (0.25 mm)	101 nL	15,000 psi (1,034 bar)	ea.



VHP MicroTight[®] Unions

- › Featuring stainless steel bodies and PK/PEEK fittings
- › Pressure rated up to 15,000 psi (1,034 bar)
- › Options to direct-connect both 1/32" OD tubing and 360 µm OD tubing

VHP Unions for Capillary Tubing

IDEX Health & Science has expanded its line of specialized fittings and connectors for UHPLC applications to include several innovative unions and adapters.

Two of these products — the UH-432 and UH-436 — follow the design of our popular Mini MicroFilters (see page 109) and allow a convenient union between either 1/32" OD tubing or 360 µm OD tubing. Each features a stainless steel union body and a unique stainless steel union capsule, enabling both excellent chemical compatibility as well as conductivity, making these a great choice for electrical interfacing in certain LC-MS applications. Each is also coupled with direct-connect ferrules made from our proprietary PEEK polymer blend (PK), allowing tubing connections up to 15,000 psi (1,034 bar). *(Please Note: While these connectors can be used at elevated pressures, they are not recommended for applications above 100 °C.)*

The UH-632 is a more traditionally designed connector, incorporating internally threaded ports. The union (UH-632) features a true ZDV (zero dead volume) connection between both tubes. This unique product is coupled with our one-piece Ultra-High Performance Fingertight fittings manufactured from our proprietary PEEK polymer blend, allowing them to be used in high temperature applications (up to 200 °C) at pressures up to 6,000 psi (414 bar) — or use these connectors at room temperature up to 15,000 psi (1,034 bar)!

The 1959-01 is a new VHP union designed to accept the popular M4x0.7 threaded fittings for 1/32" OD tubing. These unions will work nicely with both the VHP-900 fittings (found on page 59) as well as the reusable VHP-920 (found on page 60).

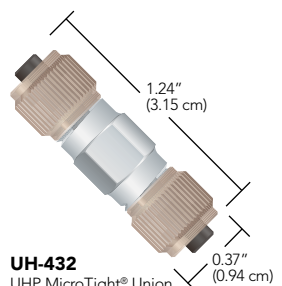

UH-432
UHP MicroTight[®] Union
for 1/32" OD tubing
with fittings and capsule union included

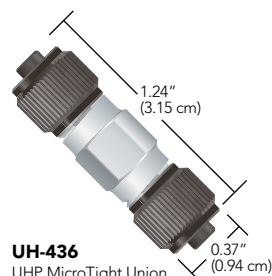

UH-436
UHP MicroTight Union
for 360 µm OD tubing
with fittings and capsule union included

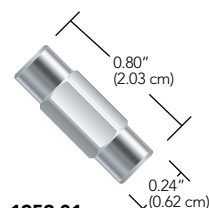

1959-01
UHP MicroTight[®] Union
for 1/32" OD tubing

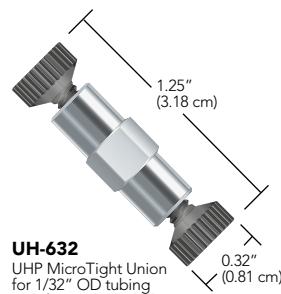

UH-632
UHP MicroTight Union
for 1/32" OD tubing
with fittings included

VHP MicroTight® Unions (Cont.)

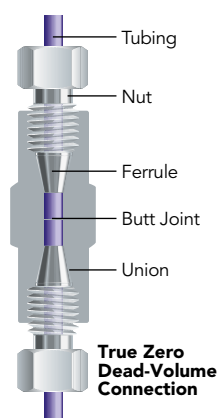

APPLICATION NOTE

What is a True ZDV Union?

True zero dead volume (ZDV) unions are designed so that the two joined pieces of tubing butt perfectly together as shown in the image to the right. These products have no swept volume contained within the union body. The fluid moves directly from one tube into another in this type of connector.

When using true ZDV unions, it is important to take care to ensure connecting tubing has burr-free 90 degree ends. Find tubing cutters on page 28 to assist with cleanly cutting polymer and fused silica tubing. Gauge plugs are supplied with True ZDV Unions to assist with assembly. With the gauge plug inserted into one side of the union, a hard stop is created for the tubing to bottom out against as it is connected to the opposite port. The gauge plug is removed and then the second piece of tubing is connected, using the first piece of tubing to bottom out against resulting in the two tubes joined together in the center of the union.

RELATED PRODUCTS

- › Find replacement VHP fittings on page 59.
- › Find Fused Silica tubing on page 16.
- › Find 1/32" OD Stainless Steel tubing on page 19.
- › To achieve 15,000 psi (1,034 bar) with the female threaded fittings used with some of these products, use the P-278 extender tool found on page 50.

VHP MicroTight Unions

Part No.	Description	Threads	Includes	Thru-hole	Swept Volume	Pressure Rating	Qty.
VHP UNIONS FOR CAPILLARY TUBING							
UH-432	VHP Union for 1/32" OD Tubing, PEEK/SST	5/16-24 Coned	(2) PK-112, (2) P-416	0.006" (0.150 mm)	5 nL	15,000 psi (1,034 bar)	ea.
UH-436	VHP Union for 360 µm OD Tubing, PEEK/SST	5/16-24 Coned	(2) PK-152, (2) P-416BLK	0.006" (0.150 mm)	5 nL	15,000 psi (1,034 bar)	ea.
UH-632	VHP True ZDV Union for 1/32" OD Tubing, PEEK/SST	6-32 Coned	(2) PK-126, (1) P-553 Gauge Plug	N/A	N/A	15,000 psi (1,034 bar)	ea.
1959-01	VHP Union for 1/32" OD Tubing, SST	M4x0.7	N/A (Fittings must be ordered separately)	0.007" (178 µm)	16 nL	30,000 psi (2,070 bar)	ea.



MicroTight[®] Adapters

- › Convenient adapters for common 1/16" OD to capillary tubing
- › Direct connect to 1/32" OD or 360 µm OD tubing options available
- › VHP adapters pressure rated to 12,000 psi (828 bar)

NOTE

While many 10-32 coned fittings are interchangeable, coned fittings using different threads are generally not interchangeable. As such, IDEX Health & Science recommends that only the style of coned fittings that accompanies these connectors be used for replacements.

Create a true zero dead volume (ZDV) connection between 1/16" OD tubing and capillary tubing with our MicroTight Adapters.

For Very High Pressure applications the UH-630 will connect 1/16" OD to 1/32" OD tubing in an inline true ZDV connection with the ability to withstand 12,000 psi (828 bar)! The materials of construction also allow this product to be used up to 200 °C, which reduces the pressure rating to 8,000 psi (552 bar). For more information on the fittings used with the VHP adapter, please see page 59.

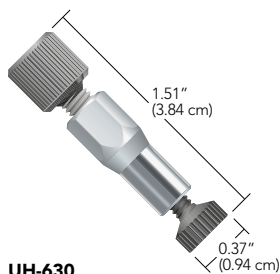

UH-630
VHP MicroTight Adapter for 1/16" and 1/32" OD tubing with fittings included

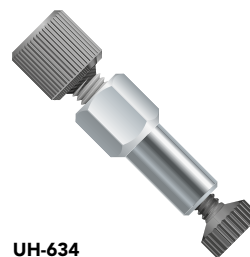

UH-634
VHP MicroTight Adapter for 1/16" and 360 µm OD tubing with fittings included

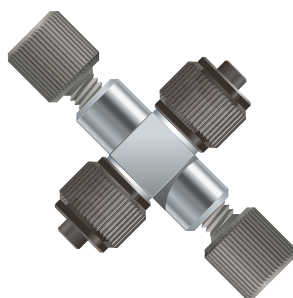

UH-906
VHP MicroTight Adapting Cross 10-32 Coned for 1/16" OD tubing and 5/16-24 Coned for 360 µm OD tubing

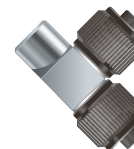

UH-753
VHP MicroTight Adapting Tee 360 µm (2 ports) to 10-32 C for 1/16" OD tubing (1 port)



UH-631-01
VHP MicroTight Adapter 10-32 Coned for 1/16" OD tubing and 6-40 Coned for 1/32" OD tubing fittings not included



1958-01
VHP MicroTight Adapter 10-32 Coned for 1/16" OD tubing and M4x0.7 for 1/32" OD tubing

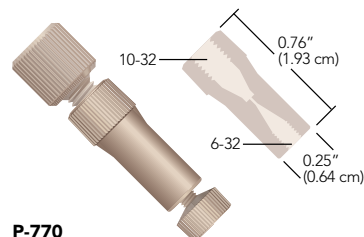

P-770
MicroTight ZDV Adapter for 1/16" OD to MicroTight Sleeves with fittings included

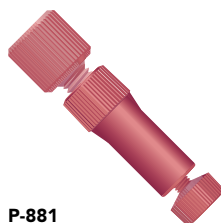

P-881
MicroTight ZDV Adapter for 1/16" to 1/32" OD tubing with fittings included

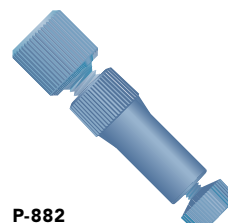

P-882
MicroTight ZDV Adapter for 1/16" to 360 µm OD tubing with fittings included

MicroTight® Adapters (Cont.)



RELATED PRODUCTS

- › Replacement 6-32 fittings are on page 34.
- › Replacement F-120 style nuts are on page 32 (when ordering, replace the “x” with an “R” or “B” to order either red or blue fittings).
- › Use this list to find micro flow products outside this chapter.

	Page
360 µm, 510 µm (0.020”), and 1/32” OD PEEK Tubing	16
360 µm OD Fused Silica Tubing	16
1/16” and 1/32” OD PEEKsil™ Tubing	22
1/32” OD FEP Tubing	26
360 µm OD High Purity PFA Tubing	24
510 µm (0.020”) and 1/32” OD Stainless Steel Tubing	19
Polymer Capillary and Fused Silica Tubing Cutters	28
MX Series II™ Injection and Switching Valves	119
Manual Injection Valves	121
Micro Injection Port Adapters	132
Micro-Splitter Valves	140
Micro-Metering Valves	141
Microbore Guard Column	158
Ultra-Low Volume Back-Pressure Regulators	144
Nonmetallic 10-32 Micro-Volume Inline Check Valve	137

MicroTight® Adapters

Part No.	Description	Threads	Includes	Color	Swept Volume	Pressure Rating	Qty.
MICROTIGHT ADAPTERS							
P-770	PEEK Micro Adapter, True ZDV, for 1/16” OD Tubing to MicroTight Tubing Sleeve	10-32 C to 6-32 C	(1) F-120, (1) F-125, (1) P-554	Natural	N/A	4,000 psi (276 bar)	ea.
P-881	PEEK Micro Adapter, True ZDV, for 1/16” to 1/32” OD Tubing	10-32 C to 6-32 C	(1) F-120R, (1) F-126S, (1) P-554	Red	N/A	5,000 psi (345 bar)	ea.
P-882	PEEK Micro Adapter, True ZDV, for 1/16” to 360 µm OD Tubing	10-32 C to 6-32 C	(1) F-120B, (1) F-124S, (1) P-554	Blue	N/A	5,000 psi (345 bar)	ea.
UH-630	Stainless Steel VHP Micro Adapter, for 1/16” to 1/32” OD Tubing	10-32 C to 6-32 C	(1) PK-120BLK, (1) PK-126, (1) P-554	SST/Black	N/A	12,000 psi (827 bar)	ea.
UH-634	Stainless Steel VHP Micro Adapter, for 1/16” to 360 µm OD Tubing	10-32 C to 6-32 C	(1) PK-120BLK, (1) PK-124, (1) P-554	SST/Black	N/A	12,000 psi (827 bar)	ea.
UH-753	Stainless Steel VHP Micro Adapting Tee, for 1/16” to 360 µm OD Tubing	10-32 C to 5/16-24 C	(2) P-416BLK, (2) PK-152	SST/Black	152 nL	15,000 psi (1,035 bar)*	ea.
1958-01	Stainless Steel VHP Micro Adapter, for 1/16” to 1/32” OD Tubing	10-32 C to M4x0.7 C	N/A	SST	16 nL	30,000 psi (2,070 bar)*	ea.
UH-631-01	Stainless Steel VHP Micro Adapter, for 1/16” to 1/32” OD Tubing	10-32 C to 6-40 C	N/A	SST	13 nL	30,000 psi (2,070 bar)*	ea.
UH-906	Stainless Steel VHP Micro Adapting Cross, for 1/16” to 360 µm OD Tubing	10-32 C to 5/16-24 C	(2) PK-120BLK, (2) P-416BLK, (2) PK-152	SST/Black	0.11 µL	15,000 psi (1,035 bar)*	ea.
REPLACEMENT GAUGE PLUGS (TO ACHIEVE TRUE ZDV CONNECTIONS WITH THE ABOVE ADAPTERS)							
P-554	Delrin® Gauge Plug	10-32 C		White	N/A	N/A	ea.
C = Coned							
* Pressure rating depends upon the fitting used.							



Accessories

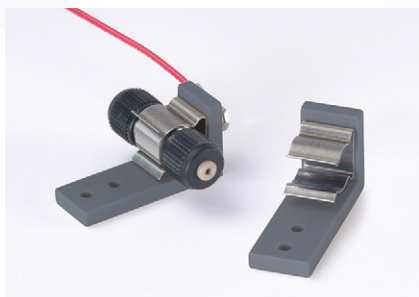

Insulating Mounting Bracket, shown with lead wire and Conductive MicroTight Union, not included.

Insulating Mounting Bracket

Use our Insulating Mounting Bracket to easily integrate the Conductive MicroTight Union (shown on page 71) or our Conductive Mini MicroFilters (on page 109) into your system or lab.

The product snaps into place. Voltage from your lead wire is conducted through the attaching stainless steel nut and screw (included), then onto the mounted product via the stainless steel clip.

The bracket's base includes two holes (#2 screw clearance) for easy mounting onto any lab surface. Dimensions are 1.25" L x 0.45" W x 0.63" H.

Part No.	Description	Threads	Includes	Thru-hole	Swept Volume	Pressure Rating	Qty.
INSULATING MOUNTING BRACKET							
M-447	Insulating Mounting Bracket	N/A	N/A	N/A	N/A	N/A	ea.



NanoPort Assemblies

- › For lab-on-a-chip applications
- › Options to connect 1/16" OD Tubing directly, or 360µm and 1/32" OD Tubing with tubing sleeves
- › **Wetted materials:**
PEEK and perfluoroelastomer

NanoPort Assemblies provide consistent fluid connections for chip-based analyses. NanoPort connections will bond to a variety of substrate materials with the use of Loctite.™

All NanoPort components are made of inert, biocompatible PEEK polymer (nuts and ports), Perlast® perfluoroelastomer (gaskets), and ETFE (ferrules). Their unique design also prevents adhesive contamination of the fluid path. And NanoPort connections add no additional volume to the fluid path, virtually eliminating dead volume traditionally associated with chip-based fluid connections.

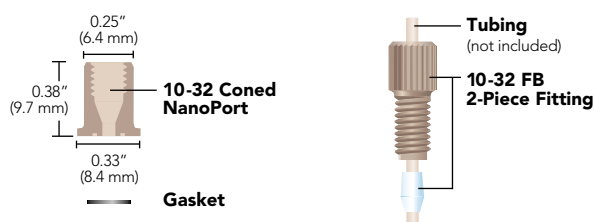

NOTE

Our NanoPort Assembly will readily connect 1/16" OD tubing with the included fittings. To connect 1/32" OD or 360µm OD, tubing sleeves for each size are included in each assembly.

Adhesive is not included in the N-333 NanoPort Assembly. Please contact IDEX Health & Science for bonding information or use common bonding adhesives such as Loctite.

Part No.	Description	Threads	For Chip Hole	Tubing OD	Qty.
NANOPORT ASSEMBLIES					
10-32 Coned NanoPort Assembly					
N-333	F-333N	F-142N	Up to 0.063" (1.6 mm)	1/16"	ea.
NANOPORT REPLACEMENT PARTS					
F-333Nx	Headless Fittings	10-32 C	Up to 0.063" (1.6 mm)	1/16"	10-pk
F-142Nx	Ferrules	10-32 C	Up to 0.063" (1.6 mm)	1/16"	10-pk
Gaskets					
N-123-02	Gasket, For all assemblies except 6-32 Coned Assemblies		N/A	N/A	ea.



Low Pressure Manifolds

Choose a 5, 7, or 9 Port Manifold to combine several streams into one, or split one fluid stream into several. Each PEEK manifold comes complete with 1/4-28 Super Flangeless™ Fittings for either 1/16" or 1/8" OD tubing, with pressure ratings of 2,000 psi (138 bar) and 500 psi (34 bar), respectively.

A few useful applications include:

- › Multiport mixing chamber
- › Gas sparging splitting union
- › Sample injection onto multi-well plates or a multiple direction flow path union

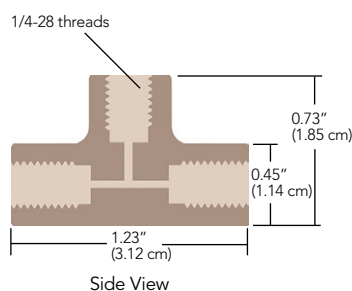

P-150
PEEK 7-Port Manifold
comes with Super Flangeless Fittings

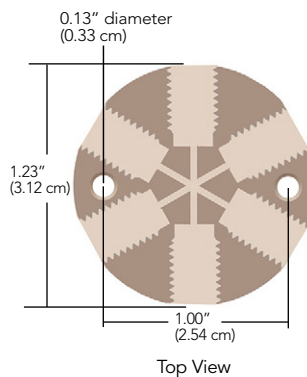

Part No.	Description	Threads	Includes	Thru-hole	Swept Volume	Pressure Rating	Qty.
MANIFOLDS							
Standard							
P-150	PEEK 7-Port Manifold for 1/16" OD Tubing	1/4-28 FB	(7) P-255, (7) P-250	0.040" (1.00 mm)	42.0 µL	1,000 psi (69 bar)	ea.
P-154	PEEK 5-Port Manifold for 1/16" OD Tubing	1/4-28 FB	(5) P-255, (5) P-250	0.040" (1.00 mm)	22.3 µL	1,000 psi (69 bar)	ea.
P-155	PEEK 5-Port Manifold for 1/8" OD Tubing	1/4-28 FB	(5) P-331, (5) P-359	0.062" (1.60 mm)	53.8 µL	500 psi (34 bar)	ea.
P-190	PEEK 9-Port Manifold for 1/8" OD Tubing	1/4-28 FB	(9) P-331, (9) P-359	0.062" (1.60 mm)	160 µL	500 psi (34 bar)	ea.
P-191	PEEK 9-Port Manifold for 1/16" OD Tubing	1/4-28 FB	(9) P-255, (9) P-250	0.040" (1.00 mm)	139 µL	1,000 psi (69 bar)	ea.

FB = Flat Bottom

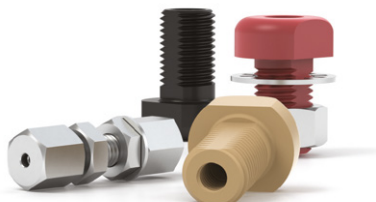

Low Pressure Bulkhead Unions

- › Designed for plumbing tubing through equipment housing
- › For use with standard 10-32 coned or 1/4-28 flat-bottom threaded fittings

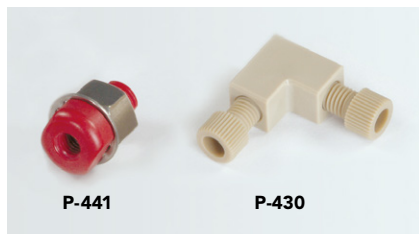
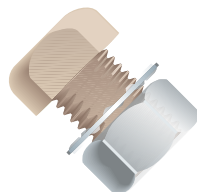
**P-441****P-430**

Bulkhead Union
includes stainless steel nut/lock washer

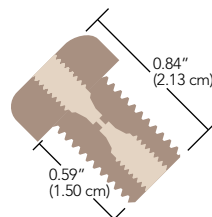

P-440
10-32 internal threads

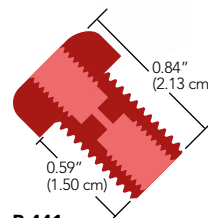

P-441
1/4-28 internal threads

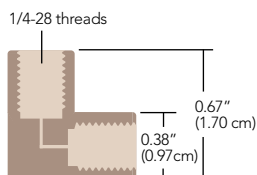

P-430
PEEK Elbow comes with Flangeless Fittings

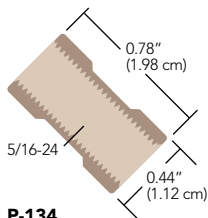

P-134
PEEK ZDV Union

Thread PEEK Bulkhead Unions directly through your equipment housing to connect internal tubing to the outside. Each union has unique 3/8-24 external threads and comes complete with a stainless steel nut and lock washer to hold it in place. Requires a 3/8" hole to mount. The recommended torque limit for these unions is 15 in.-lbs (1.7 N-m).

Elbow Connectors

Use these Elbow Connectors to easily navigate tight corners. One Elbow is designed for use with 1/16" OD tubing and has a 0.020" (0.50 mm) thru-hole. Use 1/8" OD tubing with the other Elbow, which has a 0.062" (1.6 mm) thru-hole. Both come complete with 1/4-28 PEEK nuts and ETFE ferrules, and are pressure rated to 1,000 psi (69 bar).

Large Bore Union

- › 5/16-24 flat-bottom threads

Use any of the 5/16-24 fittings on page 55 and the appropriate ferrule to create a true zero dead volume (ZDV) connection with the P-134 Union.



RELATED PRODUCTS

- › Stainless Steel Bulkhead Unions are also available. Please contact us for more information.
- › To use Elbows in higher pressure applications, simply replace the provided fittings with Super Flangeless™ Nuts and Ferrules, found on page 39.

Part No.	Description	Threads	Color	Includes	Thru-hole	Swept Volume	Qty.
BULKHEAD UNIONS							
P-440	PEEK Bulkhead Union	10-32 Coned	Natural	(1) SST Nut/Washer	0.020" (0.50 mm)	1.9 µL	ea.
P-441	PEEK Bulkhead Union	1/4-28 Flat-Bottom	Red	(1) SST Nut/Washer	0.040" (1.00 mm)	2.9 µL	ea.
P-441N	PEEK Bulkhead Union	1/4-28 Flat-Bottom	Natural	(1) SST Nut/Washer	0.040" (1.00 mm)	2.9 µL	ea.
ELBOW CONNECTORS							
P-430	PEEK Elbow for 1/16" OD Tubing	1/4-28 Flat-Bottom	Natural	(2) XP-235	0.020" (0.50 mm)	1.4 µL	ea.
P-432	PEEK Elbow for 1/8" OD Tubing	1/4-28 Flat-Bottom	Natural	(2) XP-335	0.062" (1.60 mm)	13.6 µL	ea.
LARGE BORE UNION							
P-134	PEEK True ZDV Union	5/16-24 Flat-Bottom	Natural	N/A	N/A	N/A	ea.



Low Pressure Y Connectors

PEEK Y Connectors are designed to split a stream or join two streams together, just like a tee. However, the configuration of a tee can lead to turbulent flow and solvent outgassing, which increases baseline noise and reduces sensitivity. The geometry of a Y connector creates less turbulence and thus can improve analytical results.

All of these Y Connectors use 1/4-28 Flangeless fittings, except P-515 which uses 5/16-24 fittings (to accommodate larger tubing).

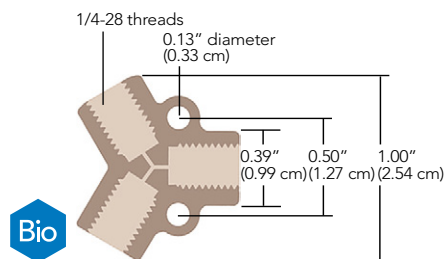

P-512
PEEK Y comes with Flangeless Fittings

Part No.	Description	Threads	Includes	Thru-hole	Swept Volume	Pressure Rating	Qty.
Y CONNECTORS							
P-512	PEEK Y for 1/16" OD Tubing	1/4-28 FB	(3) XP-235	0.020" (0.50 mm)	1.7 μ L	1,000 psi (69 bar)	ea.
P-513	PEEK Y for 1/8" OD Tubing	1/4-28 FB	(3) XP-335	0.040" (1.00 mm)	6.0 μ L	500 psi (34 bar)	ea.
P-514	PEEK Y for 1/8" OD Tubing	1/4-28 FB	(3) XP-335	0.060" (1.50 mm)	13.6 μ L	500 psi (34 bar)	ea.
P-515	PEEK Y for 3/16" OD Tubing	5/16-24 FB	(3) XP-132	0.125" (3.20 mm)	47.7 μ L	500 psi (34 bar)	ea.

FB = Flat-Bottom



- › Manufactured from PEEK, ETFE, Delrin®, polypropylene, or PCTFE
- › Available with 1/4-28, M6, or 10-32 flat-bottom threads

Low Pressure Unions

Our Low Pressure Unions are available in a variety of polymers, providing several low-cost and chemically-resistant options. The union assemblies below include fittings as shown in the table. The unions in the right column do not include fittings, allowing for customizing the fitting selection. In some cases, a union can be configured to connect two different tubing sizes—for example, if 1/4-28 Flangeless fittings for 1/16" and 1/8" OD tubing were selected from page 45 they can be used with the P-603 union to connect the two different tubing sizes.

Low Pressure PEEK Union Assemblies

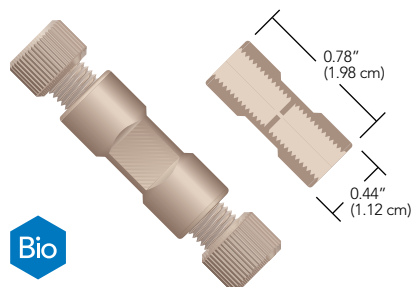

P-702 & P-703
PEEK Unions with Flangeless Fittings
(1/4-28 internal threads)

Low Pressure ETFE Union Assemblies

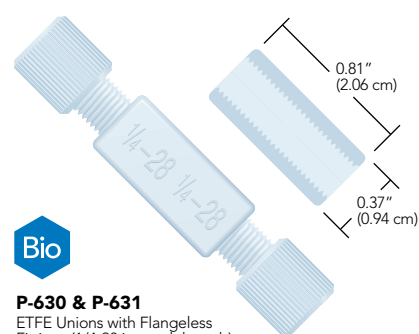

P-630 & P-631
ETFE Unions with Flangeless Fittings
(1/4-28 internal threads)

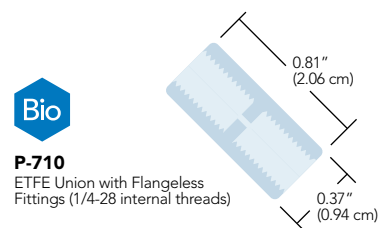

P-710
ETFE Union with Flangeless Fittings
(1/4-28 internal threads)

Low Pressure Standard Unions

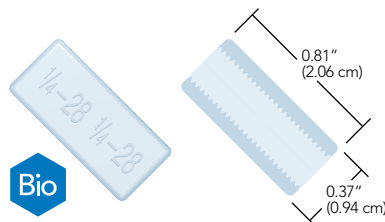

P-603, P-620 & P-623
Standard Unions (1/4-28 internal threads)

Low Pressure Metric Unions

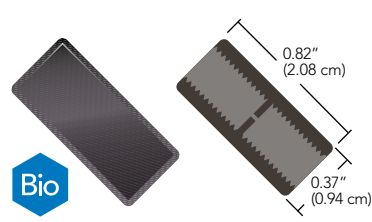

P-602 & P-622
Metric Unions (M6 internal threads)

Low Pressure Male Union

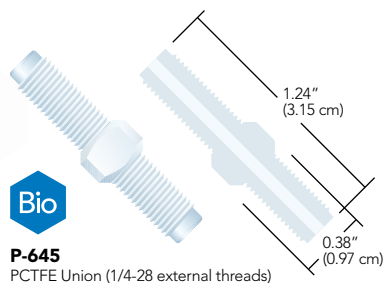

VacuTight™ Union

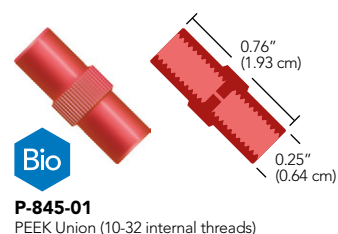

RELATED PRODUCTS

- › To use connectors in higher pressure applications, simply replace the provided fittings with Super Flangeless™ Nuts and Ferrules, found on page 39.
- › Use any of the 10-32 flat-bottom fittings on 39 and 42 to make an inline connection with our VacuTight Union. This product is designed for use with 1/16" OD tubing.

Low Pressure Unions

Part No.	Description	Color	Threads	Includes	Thru-hole	Swept Volume	Pressure Rating	Qty.
PEEK UNION ASSEMBLIES								
P-702	PEEK Union for 1/16" OD Tubing	Natural	1/4-28 FB	(2) XP-235	0.020" (0.50 mm)	0.41 µL	1,000 psi (69 bar)	ea.
P-703	PEEK Union for 1/8" OD Tubing	Natural	1/4-28 FB	(2) XP-335	0.050" (1.25 mm)	2.57 µL	1,000 psi (69 bar)	ea.
ETFE UNION ASSEMBLIES								
P-630	ETFE True ZDV Union for 1/16" OD Tubing	Natural	1/4-28 FB	(2) P-200N/P-245	N/A	N/A	1,000 psi (69 bar)	ea.
P-631	ETFE True ZDV Union for 1/8" OD Tubing	Natural	1/4-28 FB	(2) P-300N/P-345	N/A	N/A	1,000 psi (69 bar)	ea.
P-710	ETFE Union for 1/16" OD Tubing	Natural	1/4-28 FB	(2) XP-245	0.030" (0.75 mm)	0.93 µL	1,000 psi (69 bar)	ea.
STANDARD UNIONS								
P-603	Delrin True ZDV Standard Union	Natural	1/4-28 FB	N/A	N/A	N/A	N/A*	ea.
P-620	Polypropylene True ZDV Standard Union	Natural	1/4-28 FB	N/A	N/A	N/A	N/A*	ea.
P-623	ETFE True ZDV Standard Union	Natural	1/4-28 FB	N/A	N/A	N/A	N/A*	ea.
METRIC UNIONS								
P-602	Delrin Metric Union	Black	M6 FB	N/A	0.020" (0.50 mm)	0.41 µL	N/A*	ea.
P-622	ETFE Metric Union	Blue	M6 FB	N/A	0.020" (0.50 mm)	0.41 µL	N/A*	ea.
MALE UNION								
P-645	PCTFE Male Union	Natural	1/4-28 FB	N/A	0.062" (1.60 mm)	61.3 µL	500 psi (34 bar)	ea.
VACUTIGHT UNION								
P-845-01	PEEK Union for 1/16" OD Tubing	Red	10-32 FB	N/A	0.020" (0.50 mm)	0.20 µL	N/A*	ea.

* Pressure Rating depends on Fittings selected. See pressure rating for fittings on appropriate page.
FB = Flat-Bottom

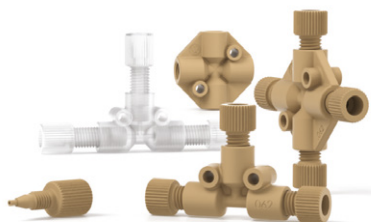

Low Pressure Tees & Crosses

Our Low Pressure Tees and Crosses are available in two inert polymers and can handle pressures to 500 psi (34 bar) or 1,000 psi (69 bar), depending upon the configuration of the products. Each is designed with handy mounting holes. All ETFE Tees and Crosses ship complete with 1/4-28 PFA Flangeless nuts and ETFE ferrules, while their PEEK polymer counterparts ship with 1/4-28 PEEK nuts and ETFE ferrules. Replacement fittings are located on page 47.

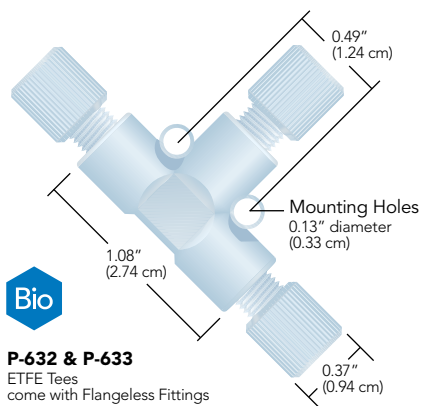

Bio

P-632 & P-633
ETFE Tees
come with Flangeless Fittings

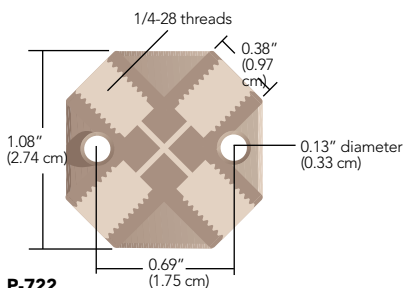

P-722
PEEK Cross
comes with Flangeless Fittings

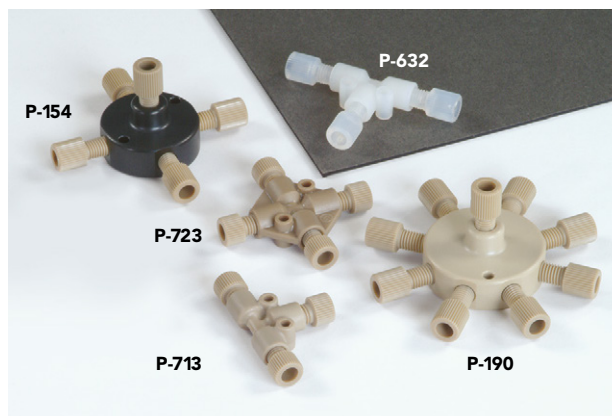

RELATED PRODUCTS

- › Seal off unused ports with any of our 1/4-28 flat-bottom plugs found on page 55.
- › To use the PEEK polymer versions of our Tees and Crosses in higher pressure applications, simply replace the provided fittings with Super Flangeless™ Nuts and Ferrules, found on page 39.
- › High Pressure Tees, Crosses, and a 7-Port Manifold (all with 10-32 threaded ports) are on page 74.

NOTE

- › To order just the body of one of our tees and crosses without fittings, simply add a '-01' to the part number — e.g., P-632-01.

Part No.	Description	Threads	Includes	Thru-hole	Swept Volume	Pressure Rating	Qty.
LOW PRESSURE TEES AND CROSSES							
P-632	ETFE Tee for 1/16" OD Tubing	1/4-28 Flat-Bottom	(3) P-245, (3) P-200N	0.020" (0.50 mm)	2.9 µL	1,000 psi (69 bar)	ea.
P-633	ETFE Tee for 1/8" OD Tubing	1/4-28 Flat-Bottom	(3) P-345, (3) P-300N	0.050" (1.25 mm)	17.5 µL	500 psi (34 bar)	ea.
P-634	ETFE Cross for 1/16" OD Tubing	1/4-28 Flat-Bottom	(4) P-245, (4) P-200N	0.020" (0.50 mm)	3.8 µL	1,000 psi (69 bar)	ea.
P-635	ETFE Cross for 1/8" OD Tubing	1/4-28 Flat-Bottom	(4) P-345, (4) P-300N	0.050" (1.25 mm)	22.8 µL	500 psi (34 bar)	ea.
P-712	PEEK Tee for 1/16" OD Tubing	1/4-28 Flat-Bottom	(3) XP-235	0.020" (0.50 mm)	2.9 µL	1,000 psi (69 bar)	ea.
P-713	PEEK Tee for 1/8" OD Tubing	1/4-28 Flat-Bottom	(3) XP-335	0.050" (1.25 mm)	17.5 µL	500 psi (34 bar)	ea.
P-714	PEEK Tee for 1/16" OD Tubing	1/4-28 Flat-Bottom	(3) XP-235	0.040" (1.00 mm)	11.4 µL	1,000 psi (69 bar)	ea.
P-722	PEEK Cross for 1/16" OD Tubing	1/4-28 Flat-Bottom	(4) XP-235	0.020" (0.50 mm)	3.8 µL	1,000 psi (69 bar)	ea.
P-723	PEEK Cross for 1/8" OD Tubing	1/4-28 Flat-Bottom	(4) XP-335	0.050" (1.25 mm)	22.8 µL	500 psi (34 bar)	ea.



Quick Connect Luer Adapters

- › Delrin®, polypropylene, ETFE, or PEEK Versions
- › Adapts luers to 1/4-28, 10-32, 5/16-24, or M6 threaded ports

These luer adapters were designed to work in a variety of applications. By connecting any male luer to any female luer, you can create your own quick connect union or adapter. Each Quick Connect Luer Adapter conforms to ISO requirements for medical luer taper configuration and performance (45 psi/3.1 bar).

Find fittings to connect tubing to the threaded ports of these adapters in the Fittings chapter, starting on page 30.

Please Note: Our Female Quick Connect Luer Adapters can be used with any of the Male Luers on this page, i.e., those with and without lock hubs.



APPLICATION NOTE

- › Our A-626 Bottle Cap Plug (page 55) can be used to plug any of the female luer adapters on this page.
- › To prevent a chemical spill when disconnecting your solvent reservoir tubing from the pump, try our Quick-Stop Luer Check Valve on page 139.
- › To economically prime an HPLC pump, simply remove the 10-32 fitting on the outlet check valve (standard on most models), insert a P-642 luer adapter, attach a syringe (such as our B-310) and draw the mobile phase through the pump head.

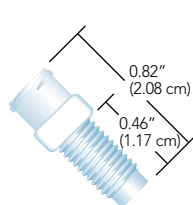

P-604, P-618, P-624
Female Luer to 1/4-28 Male
(luer end of P-604 different than shown)

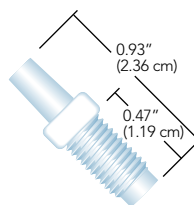

P-619, P-625
Male Luer to 1/4-28 Male

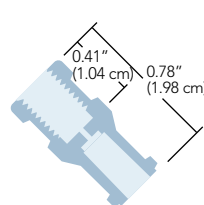

P-628
Female Luer to 1/4-28 Female

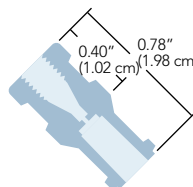

P-629
Female Luer to 10-32 Female

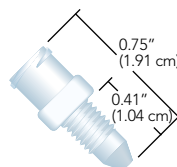

P-642
Female Luer to 10-32 Male

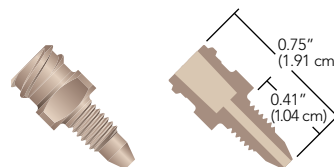

P-719
Female Luer to 10-32 Male

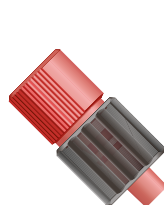

P-655, P-675
Male Luer to 1/4-28 Female

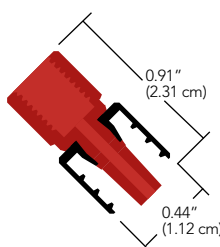

P-656
Male Luer to 10-32 Female

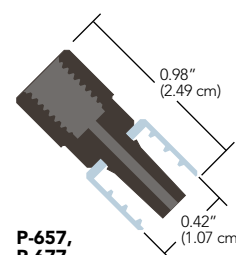

P-657, P-677
Male Luer to M6 Female

Quick Connect Luer Adapters (Cont.)

Luer-To-MicroTight® Adapter

› Easily connect 360 µm OD tubing to a syringe



P-662 Luer-to-MicroTight Adapter, shown with a B-310 Syringe (see table below) and PEEK capillary tubing (page 16), not included.

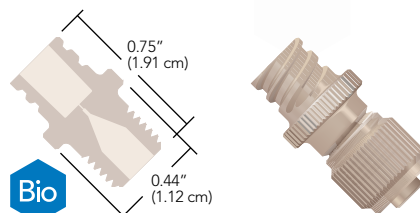

P-662
Luer-To-MicroTight Adapter for Luer to 360 µm OD tubing with fittings included

Quick Connect Luer Adapters

Part No.	Description	Body Material	Lock Hub Material	Thru-hole	Qty.
QUICK CONNECT LUER ADAPTERS					
P-604	F Luer to 1/4-28 FB, M	Nat. Delrin	N/A	0.05" (1.3 mm)	ea.
P-618	F Luer to 1/4-28 FB, M	Nat. PP	N/A	0.05" (1.3 mm)	ea.
P-619	M Luer to 1/4-28 FB, M	Nat. PP	None *	0.05" (1.3 mm)	ea.
P-624	F Luer to 1/4-28 FB, M	Nat. ETFE	N/A	0.05" (1.3 mm)	ea.
P-625	M Luer to 1/4-28 FB, M	Nat. ETFE	None *	0.04" (1.0 mm)	ea.
P-628	F Luer to 1/4-28 FB, F	Nat. ETFE	N/A	0.04" (1.0 mm)	ea.
P-629	F Luer to 10-32 C, F	Nat. ETFE	N/A	0.04" (1.0 mm)	ea.
P-642	F Luer to 10-32 C, M	Nat. ETFE	N/A	0.05" (1.3 mm)	ea.
P-655	M Luer to 1/4-28 FB, F	Red PEEK	Black PEEK	0.04" (1.3 mm)	ea.
P-656	M Luer to 10-32 C, F	Nat. PEEK	Black PEEK	0.05" (1.3 mm)	ea.
P-657	M Luer to M6 FB, F	Black PEEK	Black PEEK	0.05" (1.3 mm)	ea.
P-658	F Luer to 1/4-28 FB, F	Red PEEK	N/A	0.05" (1.3 mm)	ea.
P-659	F Luer to 10-32 C, F	Nat. PEEK	N/A	0.05" (1.3 mm)	ea.
P-660	F Luer to M6 FB, F	Black PEEK	N/A	0.05" (1.3 mm)	ea.
P-661	F Luer to 5/16-24 FB, M	Nat. ETFE	N/A	0.05" (1.3 mm)	ea.
P-675	M Luer to 1/4-28 FB, F	Red ETFE	Natural PP	0.05" (1.3 mm)	ea.
P-677	M Luer to M6 FB, F	Black ETFE	Natural PP	0.05" (1.3 mm)	ea.
P-678	F Luer to 1/4-28 FB, F	Red ETFE	N/A	0.05" (1.3 mm)	ea.
P-680	F Luer to M6 FB, F	Black ETFE	N/A	0.05" (1.3 mm)	ea.
P-683	M Luer to 1/4-28 FB, M	Nat. PEEK	Black PEEK	0.04" (1.0 mm)	ea.
P-686	F Luer to M6 FB, M	Black ETFE	N/A	0.05" (1.3 mm)	ea.
P-719	F Luer to 10-32 C, M	Nat. PEEK	N/A	0.05" (1.3 mm)	ea.
SYRINGE WITH MALE LUER LOCK					
B-310	10 cc Disposable Luer-Lock Syringe. For use with any Female Luer Adapter			0.05" (1.3 mm)	ea.
LUER-TO-MICROTIGHT ADAPTER					
P-662	Luer-to-MicroTight Adapter	(1) F-152, (1) P-416	0.006" (0.150 mm)	45 psi (2.4 bar)	ea.

F = Female (internal) threads; M = Male (external) threads; Nat. = Natural; N/A = Not Applicable;
PP = Polypropylene; FB = Flat-Bottom; C = Coned
* Slip-type male luer.



LuerTight™ Fittings

- › Luer fittings for fluoropolymer tubing
- › Quick disconnect and barbless
- › For 1/16" and 1/8" OD tubing

Our LuerTight fittings are specifically designed to connect fluoropolymer tubing without barbs or nuts! By integrating ferrules into the luer bodies, LuerTights will reliably hold your tubing in place while giving you the convenience of a luer connection. An inline set of LuerTight fittings provides a quick and easy disconnection option. LuerTight connections are also less bulky and more economical than nut-to-luer style fittings.

The bodies of these products are manufactured from polypropylene and the ferrules, where used, are made of ETFE.

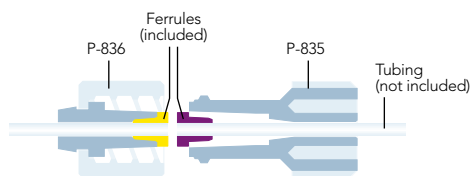

P-837
LuerTight Fittings System for 1/16" OD tubing

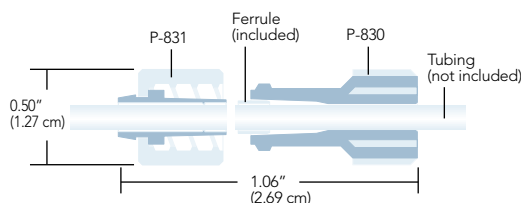

P-838
LuerTight Fittings System for 1/8" OD tubing



NOTE

LuerTight fittings are designed to be used exclusively within the LuerTight family. Combining LuerTight fittings with non-LuerTight luer products may result in a poor connection.

Part No.	Description	Includes	Thru-hole	Pressure Rating	Qty.
LUERTIGHT FITTINGS SYSTEMS					
P-837	LuerTight System for 1/16" OD Tubing	(1) P-835, (1) P-836, (1) P-830T	N/A	100 psi (7 bar)	ea.
P-838	LuerTight System for 1/8" OD Tubing	(1) P-830, (1) P-831, (1) P-830T	N/A	100 psi (7 bar)	ea.
LUERTIGHT FITTING COMPONENTS					
P-830	Female Fitting for 1/8" OD Tubing	(1) Ferrule	N/A	N/A	ea.
P-830T	Set Plug to swage Ferrules into P-835 and P-830	N/A	N/A	N/A	ea.
P-831	Male Fitting for 1/8" OD Tubing	No Ferrule Required	N/A	N/A	ea.
P-835	Female Fitting for 1/16" OD Tubing	(1) Ferrule	N/A	N/A	ea.
P-836	Male Fitting for 1/16" OD Tubing	(1) Ferrule	N/A	N/A	ea.

Female = internal receiving luer pocket; Male = external luer nose (surrounded by internally-threaded locking ring)



Barbed Connectors

Our Type 1 Barbed Unions have been engineered to effectively join two pieces of soft-walled tubing together. This type of connector is typically the connector of choice for joining two peristaltic tubes with similar inner diameters together. Our unions are manufactured from either polypropylene or nylon.

Barbed to Barbed Adapters

- › Adapters on this page feature various luer to barb adaptations
- › Adapters on the next page feature a variety of barb-to-barb connectors

Use these barbed adapters to connect peristaltic-type flexible tubing for general, low pressure applications. The polypropylene used to manufacture the majority of these products is a Class VI material. Due to the low melt point of polypropylene (PP), these adapters are not autoclavable, however, they can be sterilized via gamma radiation. There are also Barb to Female Luer-Lock connectors available from ETFE, which has superior solvent resistance and a higher temperature rating (80 °C).

Barbed "Y" Adapters

Our Barbed "Y" Adapters, manufactured from polypropylene, are engineered to effectively join three pieces of soft-walled tubing together in a Y configuration, offering less turbulence and gentler mixing of fluids than a traditional Tee Connector. This type of connector works well for joining three peristaltic tubes with similar inner diameters together.

Thread to Barbed Adapters

- › Three barb sizes, for 1/16", 1/8", and 3/16" ID flexible tubing
- › Adapt to 1/4-28 flat-bottom, 5/16-24 flat-bottom, or 10-32 coned receiving ports

These adapters make it easy to connect flexible tubing to any standard 1/4-28 flat-bottom or 10-32 coned receiving port. Simply thread the adapter into a receiving port and slip tubing over the barbed stem to create a reliable low pressure connection.

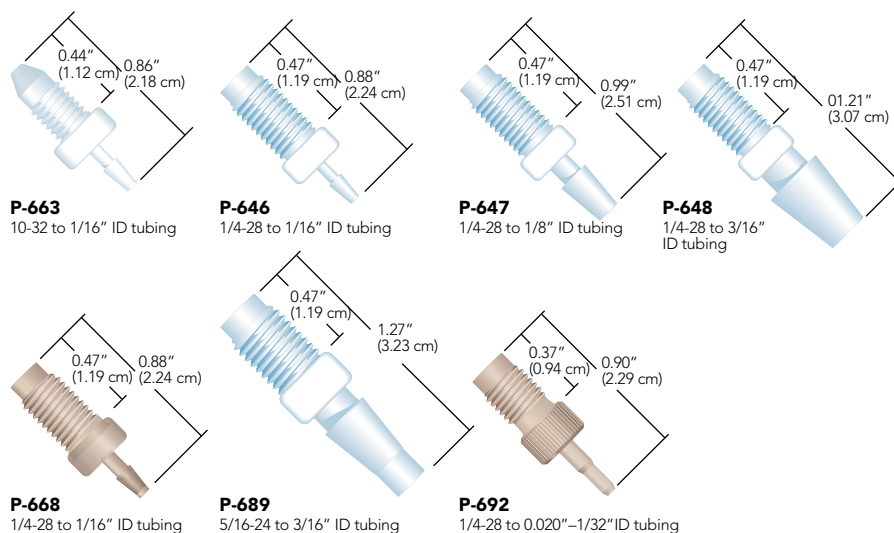



Swivel Barb Adapters

- › Barb connection spins freely from the nut to prevent twist during installation
- › Manufactured from polypropylene

The Swivel Barb Adapters from IDEX Health & Science are made up of two captive pieces acting as a one-piece fitting for ease of use. Manufactured from polypropylene and available in three barb sizes, the Swivel Barb will facilitate connection between flexible tubing to a 1/4-28 flat-bottom port. The barbed insert spins freely from the threaded nut in order to prevent the tubing from twisting during installation.

RELATED PRODUCTS

- › To connect low pressure fluoropolymer tubing, try the LuerTight™ Adapters on page 89.
- › To connect peristaltic tubing to low pressure fluoropolymer tubing, see page 92.
- › For peristaltic tubing, see page 15.

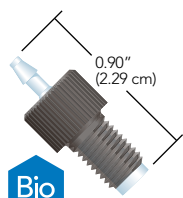

D-646
1/4-28 to 1/16" ID tubing

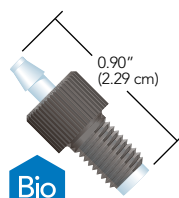

D-647
1/4-28 to 3/32" ID tubing

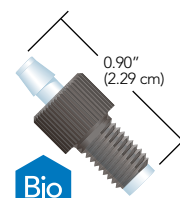

D-648
1/4-28 to 1/8" ID tubing



Luer to Barbed Adapters

Our Luer to Barbed Adapters are an excellent choice when connecting between soft-walled tubing and luer-based products, such as a syringe or a low-pressure filter, for example. We offer several different configurations, allowing you to connect various sizes of soft-walled tubing to receiving ports that accept a male luer "slip" style connection; a male luer "lock" style connection; and a female-luer style of connector.

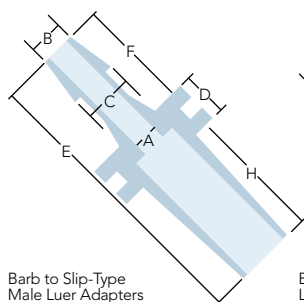

Barb to Slip-Type
Male Luer Adapters

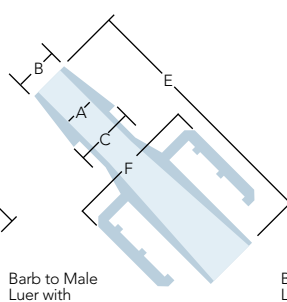

Barb to Male
Luer with
Lock Ring Adapters

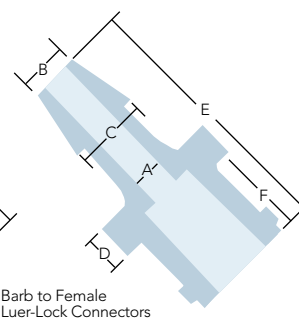

Barb to Female
Luer-Lock Connectors

Barbed Connectors (Cont.)

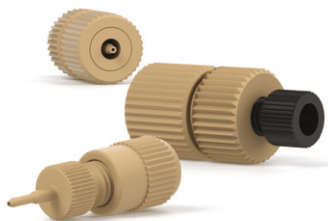

Conical Adapters

- › Direct connect 1/16" and 1/8" OD rigid and semi-rigid tubing to peristaltic tubing
- › Accept 0.020"–1/8" (0.50–3.2 mm) ID peristaltic tubing
- › Biocompatible flow path with excellent chemical compatibility

Conical Adapters provide a reliable connection between rigid/semi-rigid tubing and peristaltic-type flexible tubing, such as Tygon® and PharMed®. These adapters are composed of a PEEK polymer female nut, our Super Flangeless™ ferrule system and an ETFE or PEEK conical adapter body. The narrow coned end of the adapter body allows peristaltic tubing to slide on more easily than it does onto conventional barbed adapters. Peristaltic tubing is also easier to remove from our Conical Adapters, since no cutting or excessive pulling is required.



APPLICATION NOTE

To help secure peristaltic tubing more firmly to the Conical Adapters, simply attach a cable tie to the outside of the peristaltic tubing once it has been placed onto the Adapter body.

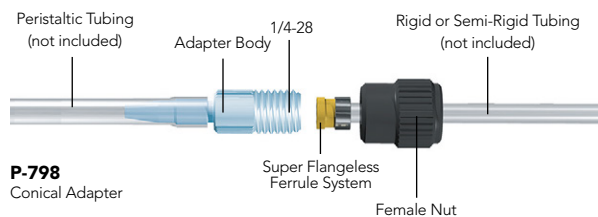
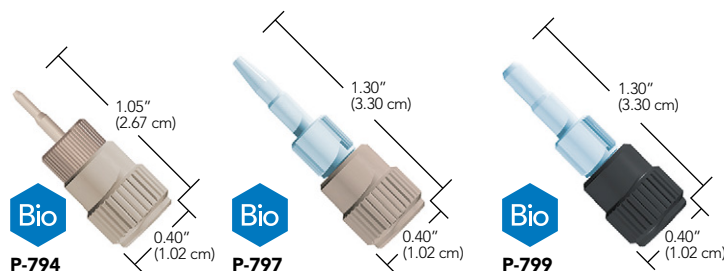

P-798
Conical Adapter

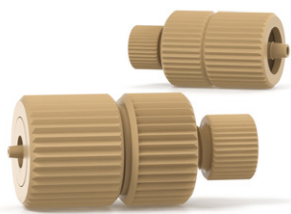

Peristaltic Tubing Adapters

These unique adapters connect peristaltic tubing to standard 1/16" or 1/8" OD tubing. A specially-designed nose allows the peristaltic tubing to simply press fit over the nose and then be held tightly in place by the retainer sleeve. Your 1/16" OD tubing may then be connected with the Flangeless Fittings supplied with the adapter. To connect your peristaltic tubing to tubing with a different OD, simply replace the supplied fittings with your choice of Flangeless Fittings from page 45.

One popular application for these adapters is to use them as "stops" for your peristaltic pump. By doing so, you can reduce the amount of peristaltic tubing required for your flow path, thus reducing cost.

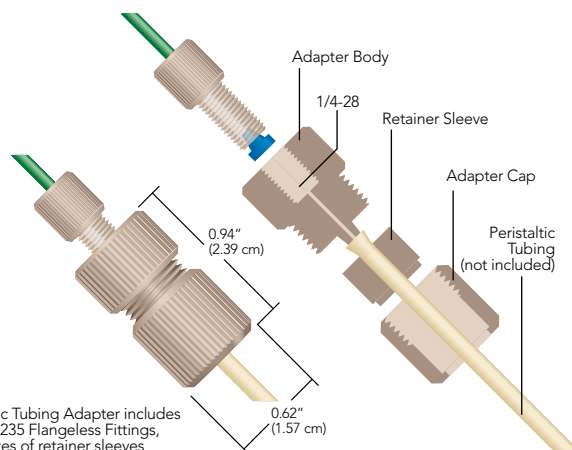

P-757
Peristaltic Tubing Adapter includes P-200/P-235 Flangeless Fittings, and 3 sizes of retainer sleeves

Barbed Connectors

Part No.	Tubing ID	Material	Qty.		
BARBED TO BARBED ADAPTERS					
P-801	0.06" (1.5 mm)	Polypropylene	ea.		
P-802	0.12" (3.0 mm)	Polypropylene	ea.		
BARBED "Y" CONNECTORS					
P-860	0.06" (1.5 mm)	Polypropylene	ea.		
P-861	0.10" (2.5 mm)	Polypropylene	ea.		
P-862	0.12" (3.0 mm)	Polypropylene	ea.		
P-863	0.18" (4.8 mm)	Polypropylene	ea.		
P-864	0.25" (6.4 mm)	Polypropylene	ea.		
THREAD TO BARBED ADAPTERS					
Part No.	Description	Material	Threads	Thru-hole	Qty.
P-663	Barb Adapter, 1/16" (1.55 mm) ID Tubing	ETFE	10-32 Coned	0.04" (1.0 mm)	ea.
P-646	Barb Adapter, 1/16" (1.55 mm) ID Tubing	ETFE	1/4-28 Flat-Bottom	0.04" (1.0 mm)	ea.
P-647	Barb Adapter, 1/8" (3.20 mm) ID Tubing	ETFE	1/4-28 Flat-Bottom	0.08" (2.0 mm)	ea.
P-648	Barb Adapter, 3/16" (4.75 mm) ID Tubing	ETFE	1/4-28 Flat-Bottom	0.10" (2.5 mm)	ea.
P-668	Barb Adapter, 1/16" (1.55 mm) ID Tubing	PEEK	1/4-28 Flat-Bottom	0.04" (1.0 mm)	ea.
P-689	Barb Adapter, 3/16" (4.75 mm) ID Tubing	ETFE	5/16-24 Flat-Bottom	0.10" (2.5 mm)	ea.
P-692	Barb Adapter, 0.020" to 1/32" (0.50 to 0.80 mm) ID Tubing	PEEK	1/4-28 Flat-Bottom	0.02" (0.5 mm)	ea.
SWIVEL BARB ADAPTERS					
D-646	Swivel Barb Adapter, 1/16" (1.55 mm) ID Tubing	Polypropylene	1/4-28 Flat-Bottom	0.03" (0.75 mm)	ea.
D-647	Swivel Barb Adapter, 3/32" (2.40 mm) ID Tubing	Polypropylene	1/4-28 Flat-Bottom	0.056" (1.5 mm)	ea.
D-648	Swivel Barb Adapter, 1/8" (3.20 mm) ID Tubing	Polypropylene	1/4-28 Flat-Bottom	0.08" (2.0 mm)	ea.
BARB TO SLIP-TYPE MALE LUER ADAPTERS					
Part No.	Description	Material	Qty.		
P-854	Male Luers (Slip-type) for use with 1/16" ID (1.55 mm) Tubing A=0.046" B=0.064" C=0.090" D=0.129" E=0.711" F=0.198" H=0.384"	PP	ea.		
<i>These slip-type male luer fittings are for use in systems for which luer lock rings are not desired.</i>					
BARB TO MALE LUER WITH LOCK RING ADAPTERS					
P-850	Male Luers with Lock Ring for use with 1/16" ID (1.55 mm) Tubing A=0.049" B=0.065" C=0.090" E=0.583" F=0.434"	PP	ea.		
P-851	Male Luers with Lock Ring for use with 3/32" ID (2.40 mm) Tubing A=0.071" B=0.100" C=0.139" E=0.681" F=0.436"	PP	ea.		
P-852	Male Luers with Lock Ring for use with 1/8" ID (3.20 mm) Tubing A=0.099" B=0.132" C=0.184" E=0.777" F=0.436"	PP	ea.		
BARB TO FEMALE LUER-LOCK CONNECTORS					
P-857	Female Luer Connectors for use with 1/16" ID (1.55 mm) Tubing A=0.030" B=0.063" C=0.106" D=0.100" E=0.598" F=0.253"	PP	ea.		
P-858	Female Luer Connectors for use with 3/32" ID (2.40 mm) Tubing A=0.056" B=0.102" C=0.145" D=0.100" E=0.648" F=0.253"	PP	ea.		
P-859	Female Luer Connectors for use with 1/8" ID (3.20 mm) Tubing A=0.080" B=0.135" C=0.187" D=0.100" E=0.733" F=0.253"	PP	ea.		
P-870	For use with 1/16" (1.55 mm) ID Tubing A=0.030" B=0.063" C=0.106" D=0.100" E=0.598" F=0.253"	ETFE	ea.		
P-872	For use with 1/8" (3.20 mm) ID Tubing A=0.080" B=0.137" C=0.187" D=0.100" E=0.733" F=0.253"	ETFE	ea.		
PERISTALTIC TUBING ADAPTERS					
Part No.	Description	Tubing OD	Peristaltic Tubing ID	Thru-Hole	Qty.
P-757	Standard Adapter	up to 0.180" (4.55 mm)	0.048"–0.110" (1.20–2.80 mm)	0.030" (0.75 mm)	ea.
P-767	Large Bore Adapter	up to 0.250" (6.35 mm)	0.100"–0.150" (2.55–3.80 mm)	0.070" (1.78 mm)	ea.
CONICAL ADAPTER ASSEMBLIES					
Part No.	Description	Rigid or Semi-Rigid Tubing OD	Peristaltic Tubing ID	Thru-Hole	Qty.
P-794	Conical Adapter	1/16"	0.020"–0.030" (0.50 mm–0.75 mm)	0.020" (0.50 mm)	ea.
P-797	Conical Adapter	1/16"	1/16"–3/32" (1.55 mm–2.40 mm)	0.040" (1.0 mm)	ea.
P-798	Conical Adapter	1/8"	1/16"–3/32" (1.55 mm–2.40 mm)	0.040" (1.0 mm)	ea.
P-799	Conical Adapter	1/8"	3/32"–1/8" (2.40 mm–3.20 mm)	0.060" (1.5 mm)	ea.
CONICAL ADAPTER REPLACEMENT PARTS					
Part No.	Description	For Use With	Material	Qty.	
F-156	Female Nut, 1/8", 1/4-28	P-798, P-799	Black PEEK	ea.	
P-420	Female Nut, 1/16", 1/4-28	P-794, P-797	Natural PEEK	ea.	
P-259	Super Flangeless Ferrule, 1/16"	P-794, P-797	Yellow ETFE/SST	ea.	
P-359	Super Flangeless Ferrule, 1/8"	P-798, P-799	Yellow ETFE/SST	ea.	
P-691	Conical Adapter Body	P-799	Natural ETFE	ea.	
P-692	Conical Adapter Body	P-794	Natural PEEK	ea.	

LOCAL DISTRIBUTOR



For ordering and technical support, please contact:

EUROPE | BIOTECH AB | +46 (0)300-56 91 80 | info@biotechfluidics.com | www.biotechfluidics.com
USA | BIOTECH USA LLC | 612-703-5718 | sales@biotechfluidics.com | www.biotechfluidics.com
JAPAN | BIONIK INC. | +81 545-38-9125 | info@bionikinc.com | www.bionikinc.com